

# Sensyflow FMT200-ECO2 Thermal Mass Flowmeter



## Direct mass flow measurement of air

- No additional pressure and temperature compensation required
- Mass flow or standard volume flow measuring values

## Wide measuring range of 1:100

## High accuracy

## Highly dynamic, response time $\leq 90$ ms

- Optimized for advanced control systems

## Compact design with low weight

## No moving parts, no wear, maintenance-free

## Arbitrary mounting orientation

## Variable process connections

- Flanges, threads, tubes

## Variety of output signals

- Current, voltage, frequency, pulse, alarm, parameter setting via RS 232 interface

## Approvals for explosion protection (zone 2 and zone 22)

- Manufacturer's declaration according to ATEX

## Applications

- Paint robot control (Air dosing)
- Compressed air systems (Balancing, Leakage detection)
- Burner control
- Dosing technology

---

## Contents

<b>1</b>	<b>General information</b> .....	<b>3</b>
1.1	Principle of operation and construction .....	3
<b>2</b>	<b>Specifications</b> .....	<b>4</b>
<b>3</b>	<b>Electrical connections</b> .....	<b>5</b>
3.1	Cable assignments .....	5
3.2	Circuiting the signal outputs .....	5
<b>4</b>	<b>Parameterization</b> .....	<b>6</b>
4.1	Overview parameterization program Sensyflow FMT200-ECO2 .....	6
4.2	Service and parameterization box.....	7
<b>5</b>	<b>Dimensions</b> .....	<b>7</b>
5.1	Flowmeter sensor FMT200-ECO2 .....	7
5.2	Accessories .....	8
<b>6</b>	<b>Ordering information</b> .....	<b>10</b>
<b>7</b>	<b>Questionnaire</b> .....	<b>12</b>

## 1 General information

### 1.1 Principle of operation and construction

Sensyflow FMT200-ECO2 is a compact, highly dynamic measuring system for mass flow or standard volume flow measurement of air.

The device consists of an easy to install pipe component which accommodates the sensor unit and the evaluation electronics. It directly provides a linearized output signal, and it is calibrated and immediately ready for use.

A standard RS 232 interface allows you to change over between the individual output signals (current, voltage, frequency, pulse and alarm) and to configure the device.

Due to its flexible connection concept this measuring instrument can be installed in pipes or tubes of different types and sizes. Various process adapters are available for this purpose.

A standard power supply unit can be used for powering Sensyflow FMT200-ECO2.

#### Physics of measurement

Thermal flow metering procedures use different ways to evaluate the flow dependent cooling of a heated resistor as measuring signal.

In a hotfilm anemometer with temperature difference control, the heated platinum resistor is maintained at a constant overtemperature in relation to an unheated platinum sensor inside the gas flow. The heating power required for maintaining the overtemperature depends directly on the flow rate and the material properties of the gas. With a known (and constant) gas composition the mass-flow can be determined by electronically evaluating the heater current/mass-flow curve without additional pressure and temperature compensation.

Together with the standard density of the gas this results directly in the standard volume flow. Considering the high measuring range dynamics up to 1:100, an accuracy smaller than 1 % of the measuring value is achieved.

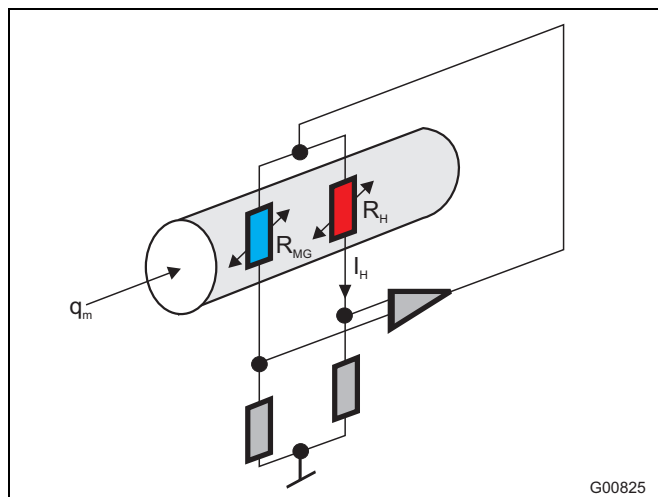

Fig. 1: Analog measuring principle

$q_m$	Gas mass-flow
$R_{MG}$	Gas temperature measuring resistor
$R_H$	Heating resistor
$I_H$	Actual value of heater

The gas stream flows past two temperature-sensitive resistors  $R_H$  and  $R_{MG}$  which are part of an electrical bridge circuit. Due to the chosen resistance ratio  $R_H < R_{MG}$ ,  $R_H$  is heated by the current  $I_H$ , and  $R_{MG}$  adopts the same temperature as the gas. The current  $I_H$  is preset by the electronic control circuit to produce a constant temperature difference between the heated resistor  $R_H$  and the temperature of the gas.

The electrical power generated with resistor  $R_H$  exactly compensates its loss of heat to the gas flow. As this loss of heat is dependent on the number of particles which collide with the surface of resistor  $R_H$ ,  $I_H$  represents a measure of the mass flow rate.

## 2 Specifications

### Measuring principle

Thermal: hot-film anemometer

### Input

#### Measured medium

Air

#### Measuring ranges<sup>1)</sup>

0 (1) ... 100 kg / h or 0 (12) ... 1250 NI / min<sup>2)</sup>

### Output

#### Analog output signal

0 ... 5 V  
0 ... 10 V  
0 / 4 ... 20 mA

#### Load

< 500 Ω

#### Error indication

< 3.5 mA or > 22 mA

#### Digital output

24 V, 20 mA

#### Frequency output

variable 1 ... 2500 Hz

#### Counter pulse

Pulse evaluation and pulse duration configurable

#### Alarm values

Minimum and maximum, adjustable

#### Polarity adjustable

#### Characteristics

##### Measured error

< ± 3 % of measured value

##### Repeatability

< ± 0.5 % of measured value

##### Response time

$T_{63} \approx 25$  ms;  $T_{98} \approx 90$  ms

#### Influences

##### Temperature effect

< 0.1 % / K of measured value

##### Pressure effect

≤ 0.2 % / 100 kPa (/bar) of measured value

##### Pressure drop

< 10 kPa (100 mbar) at full scale and using the small flange adapter DN 25; decreasing quadratically for smaller flow rates.

#### Environmental conditions

##### Ambient temperature for flowmeter sensor

0 ... 50 °C (-13 ... 122 °F)

##### Degree of protection

IP 65

##### Storage temperature

-25 ... 85 °C (-13 ... 185 °F)

#### Measured medium conditions

##### Measured medium temperature

0 ... 50 °C (32 ... 122 °F)

##### Measured medium pressure

Standard: 10 x 10<sup>2</sup> kPa (10 bar abs.)  
High pressure version: 16 x 10<sup>2</sup> kPa (16 bar abs.)

#### Construction

##### Weight

0.51 kg (accessories see ordering information)

##### Material

Flowmeter sensor: aluminium, Hostadur, tinned Cu, glass  
Process connections: aluminium  
Fittings: aluminium

##### Process connection

Small flange adapter ISO KF flange;  
Threads G 3/8", G 3/4", G 1/2", G 1";  
Legris tube adapter, Transair adapter

##### Electrical connection

Sub-D connector, serie 712, 8-pin, IP 65

##### Power supply<sup>3)</sup>

##### Voltage

24 V DC ± 10 %

##### Power consumption

< 15 W

##### Current consumption

Peak < 1 A; operation < 0.6 A  
Slow-blow fuse of at least 2 A recommended

##### Communication interface

RS 232

##### Approvals for explosion protection (zone 2 and zone 22)

Gas: ATEX II 3 G EEx n A II T4 X  
Dust: ATEX II 3 D T 135 °C IP 65 X

#### Accessories (optional)

- Inlet and outlet runs
- Pipe fittings
- Connection adapter
- Quick-clamping connectors
- Reducers
- Power supply unit
- Display unit
- Display and supply unit completely installed in an IP 65 housing

- 1) Approximate values are given for applications with air under atmospheric conditions. The values in brackets indicate the low limit of the measuring range for which the measured value accuracy indicated is specified.
- 2) It is possible to specify any unit which you can transform into a mass or standard volume flow. (Can also be written as: l / min-q<sub>n</sub>).
- 3) Power supply with safe electrical separation in accordance with EN 61010 and IEC 950, with max. output power of 150 W.

### 3 Electrical connections

Please use the supplied cable for the electrical connection of the flowmeter sensor. On the measuring unit, a connector is used for the coupling.

Use a 24 V DC power supply with isolation according to EN 61010 and IEC 950 with a maximum output of < 150 W only.

#### 3.1 Cable assignments

Color of cores	Connector pin number	Signal
White	#1	Analog output +
Brown	#2	RS 232 / TxD
Green	#3	Pulse / frequency output
Yellow	#4	Power supply 24 V DC
Grey	#5	Power supply 0 V
Pink	#6	RS 232 / RxD
Blue	#7	GND / analog
Red	#8	GND / frequency + pulse + RS 232
Shielding	-	Functional earthing

#### 3.2 Circuiting the signal outputs

##### 3.2.1 Analog output

Upon selection, the analog output of the current output supplies an active signal of 0 (4) ... 20 mA, i. e. the Sensyflow FMT200-ECO2 device supplies the current independently.

For this reason, do not use a 2-wire power supply unit or an active input of a PLC, but rather a passive signal receiver.

##### 3.2.2 Digital output

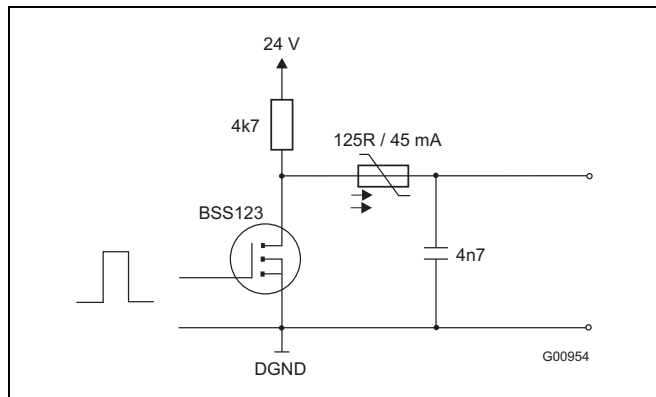

Fig. 2: Digital output

The digital output offers a 24 V = HIGH signal or a 0 V = LOW Signal. The digital output can be used as active or passive output.

##### Active digital output wiring

The output current in the HIGH-mode must be limited to 1 mA when the active digital output is used (passive signal receiver). This is to ensure an output voltage  $U_a > 15$  V.

##### Passive digital output wiring

Using the passive output (active signal receiver), the output current in the LOW-mode must be limited to -20 mA. This is to ensure an output voltage  $U_a < 2.5$  V.

##### 3.2.3 Compatibility to Sensyflow eco1

Sensyflow eco1 und Sensyflow FMT200-ECO2 are compatible. Using the appropriate electrical adapter, FMT200-ECO2 can be connected to existing plants.

As "interface" and "digital output" functionality is not available with Sensyflow eco1, there is no wiring within the adapter for these functions.

## 4 Parameterization

The Sensyflow FMT200-ECO2 can simultaneously serve one analog output (current 0 / 4 ... 20 mA or voltage 0 ... 5 / 10 V), one digital output (frequency, pulse, alarm) and a serial RS 232 interface.

Additionally, the measuring system can be configured via the serial interface. With this, it is possible to change the output signals or the settings of the measuring ranges and signals by using a standard PC or laptop.

The configuration program is included in the standard scope of delivery. A service and configuration box is available as an accessory part. It will help to connect the different signals of Sensyflow the FMT200-ECO2 quickly and easily.

### 4.1 Overview parameterization program Sensyflow FMT200-ECO2

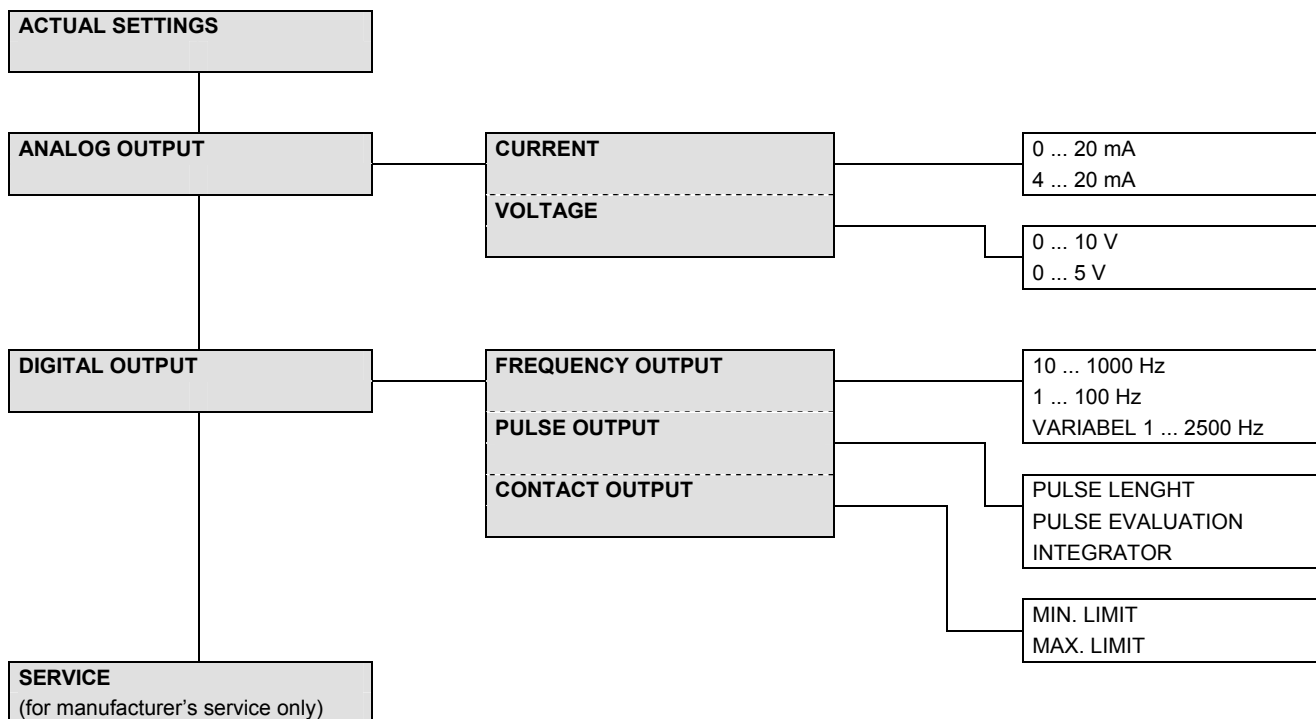

## 4.2 Service and parameterization box

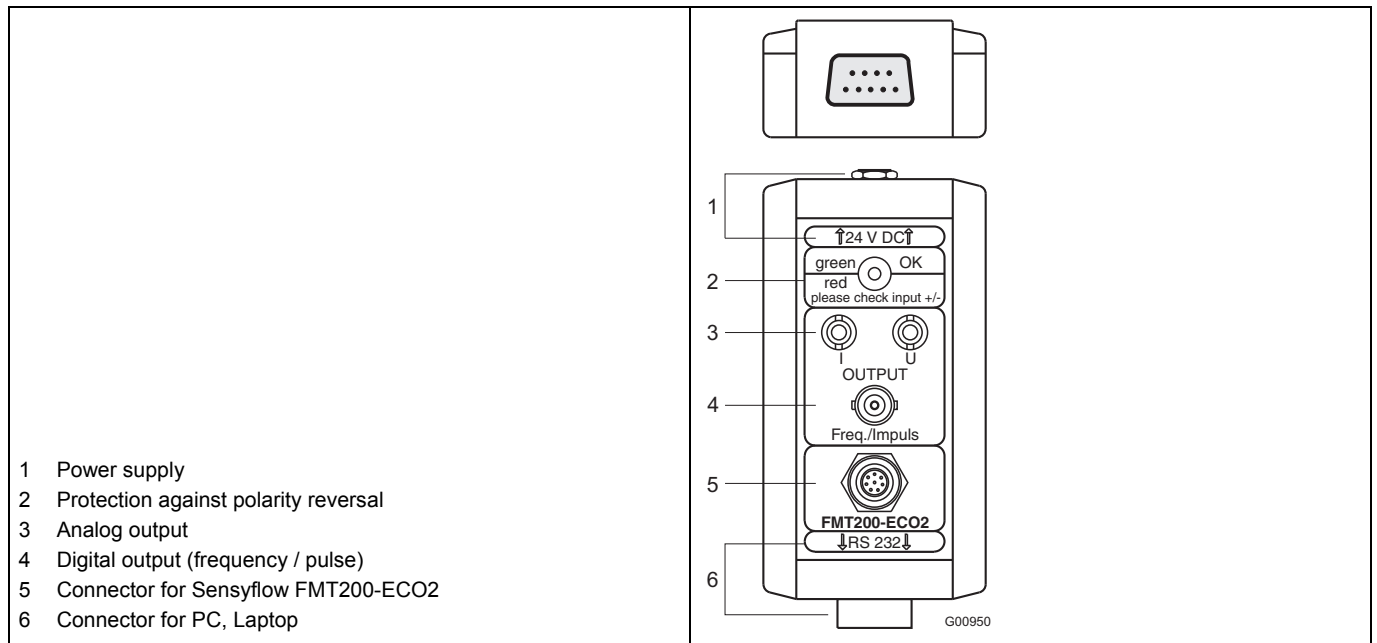

Fig. 3

## 5 Dimensions

### 5.1 Flowmeter sensor FMT200-ECO2

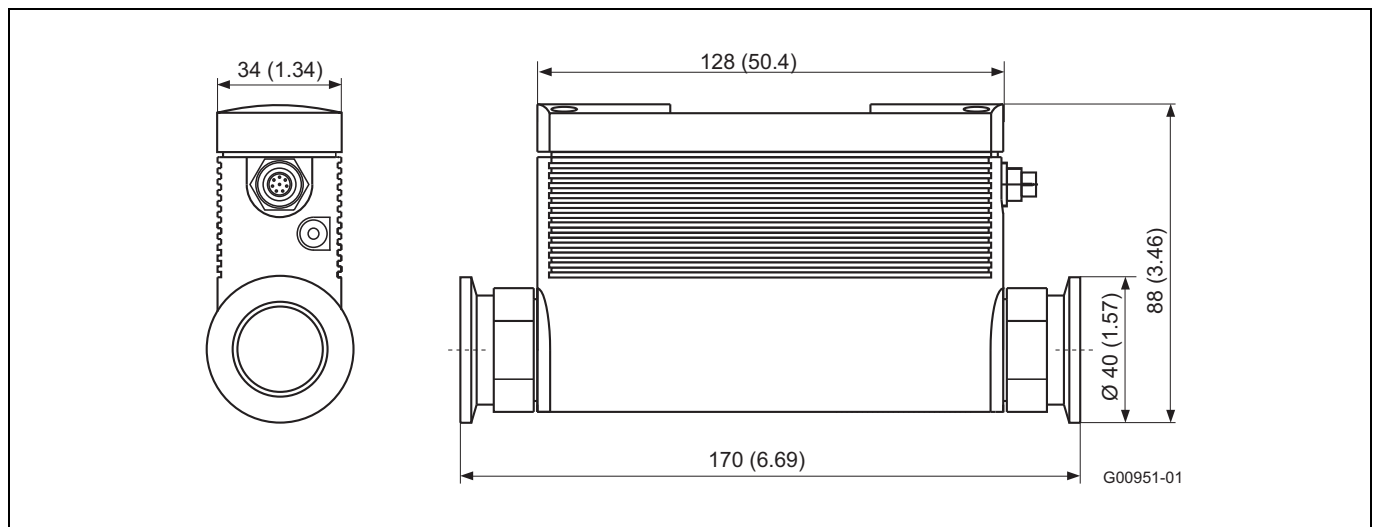
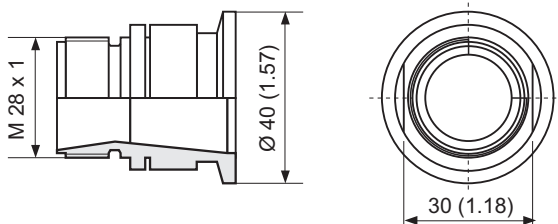

Fig. 4: Flowmeter sensor FMT200-ECO2 with mounted small flange adapter

5.2 Accessories

Small flange connections

KF = ISO KF flange (ISO small flange)



Process adapter flange KF DN 25, inlet run and outlet run, 2 clamp rings and 2 sealing rings

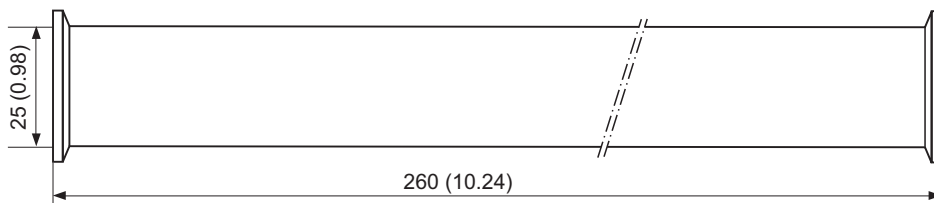

Inlet run length 10 x D, both sides with KF-DN 25 connections

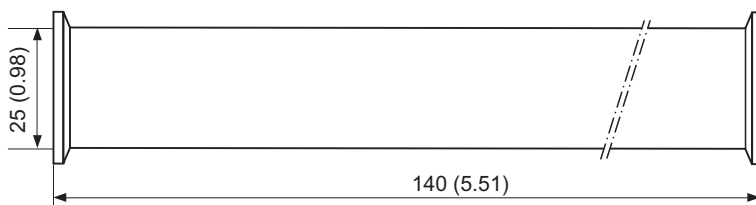

Outlet run length 5 x D, both slides with KF DN 25 connections

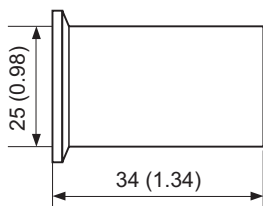

G00952

Hose adapter for KF DN 25, incl. 1 flange, 1 clamping ring and 1 sealing ring

Fig. 5: Dimensions in mm (inch)

Straight undisturbed pipes must be provided as steadying lengths. On the inlet side they should have a length of approx. 10 x D. When using the G 1/2" and G 3/8" adapters no additional steadying lengths are required, as flow-conditioning components are implemented in the adapters on the inlet side.

Note that flow conditioner causes a considerable pressure drop. Components affecting the flow like valves or shut-off devices should be installed on the outlet side, i. e. downstream of the measuring point.



**Threads and adapter**

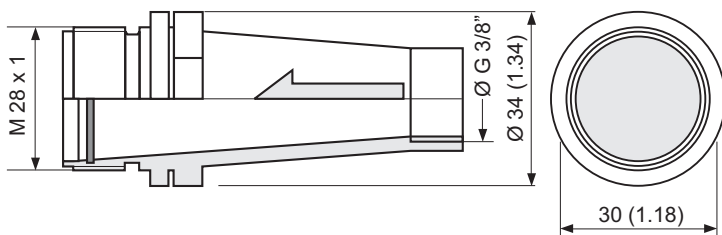

Thread G 3/8", connection for Legris-tube adapters, pair for inlet run and outlet run; inlet run adapter includes a high-tech flow conditioner

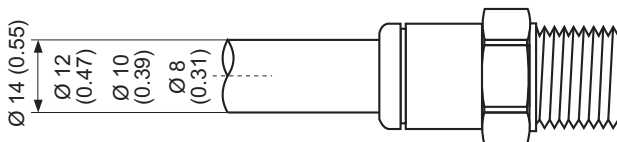

Legris-tube adapter (pair)

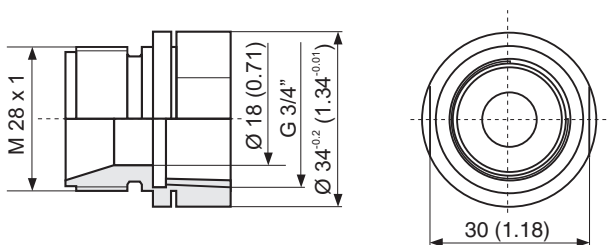

Thread G 3/4", also connection for Transair system 25 mm (pair)

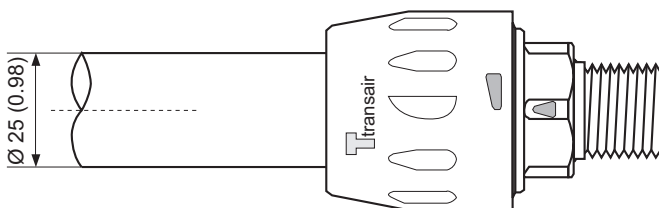

Transair adapter 25 mm (pair)

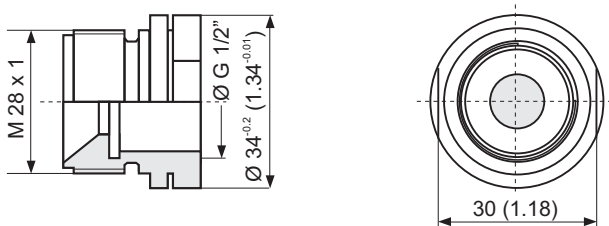

Thread G 1/2" (pair) for inlet run and outlet run. Inlet run adapter includes a high-tech flow conditioner

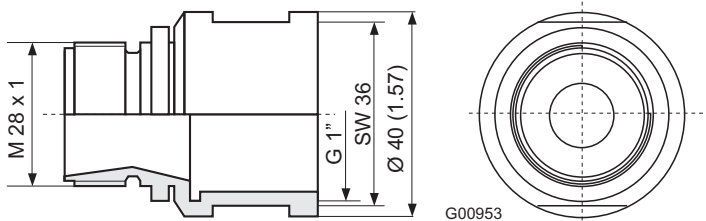

Thread G 1"

Fig. 6: Dimensions in mm (inch)

## 6 Ordering information

	Haupt-Bestellnummer						Zus. Bestellnr.	
	Variantenstelle	1 - 6	7	8	9	10	11	
<b>Sensyflow FMT200-ECO2 Thermal Mass Flowmeter, for air, compact</b>	<b>V14252</b>		X	X	X	X	X	<b>XX</b>
<b>Calibration Type / Operating Pressure</b>								
Standard calibration 0 ... 100 kg/h (0 ... 220 lbs/h) / Operating pressure 1 ... 10 bar abs. (0.1 ... 1 MPa abs. / 14.5 ... 145 psi abs.)			1					
Standard calibration 0 ... 100 kg/h (0 ... 220 lbs/h) / High pressure version, operating pressure 10 ... 16 bar abs. (1 ... 1.6 MPa abs. / 145 ... 232 psi abs.)			2					
Customer-specific calibration, operating pressure 1 ... 10 bar abs. (0.1 ... 1 MPa abs. / 14.5 ... 145 psi abs.)	1)		3					
Customer-specific calibration, high pressure version, operating pressure 10 ... 16 bar abs. (1 ... 1.6 MPa abs. / 145 ... 232 psi abs.)	1)		4					
<b>Analog Output</b>								
0 ... 5 V			1					
0 ... 10 V			2					
0 ... 20 mA, alarm > 22 mA			3					
4 ... 20 mA, alarm < 3.5 mA			4					
4 ... 20 mA, alarm > 22 mA			5					
<b>Digital Output</b>								
Counter pulse output (high level)			2)	1				
Counter pulse output (low level)			2)	2				
Frequency output, adjustable up to 2500 Hz			3)	4				
Alarm output (alarm = high)			4)	5				
Alarm output (alarm = low)			4)	6				
<b>Process Connection</b>								
1 pair of process adapters KF DN 25 (1 in.), incl. 2 clamping rings and 2 sealing rings						1		
1 pair of threads G 3/8 in., also connection for Legris-section adapters, outlet run adapter includes a high-tech flow straightener						2		
1 pair of threads G 1/2 in., outlet run adapter includes a high-tech flow straightener						3		
1 pair of threads G 3/4 in., also connection for Transair system 25 mm						4		
1 pair of threads G 1 in.						5		
Installed process adapter, KF DN25 (pair), incl. 2 clamping rings- and 2 sealing rings, hexagon socket head cap screw						6		
<b>Version</b>								
Standard							0	
ATEX version for Zone 2 / 22							1	
<b>Certificates: Calibration</b>								
Factory certificate								0
DAkKS certificate of calibration with air (not for process gas calibration)							5)	1
<b>Documentation Language</b>								
German								M1
Spanish								M3
French								M4
English								M5

- 1) Customer specific configuration: measuring range, unit of measure, normalization conditions, upper measuring range value acc. code nos. 110 and 114
- 2) State pulse evaluation with code no. 310. The digital output can have states High = 24 V or Low = 0 V. Please specify the required polarity
- 3) Standard 10 ... 1000 Hz
- 4) State alarm values with code nos. 312 ... 313
- 5) DAkKS / ILAC - accredited calibration equipment D-K-15081-01-00

Accessories	Order number
SMD130 DAkkS calibration for thermal mass flowmeter, certificate of calibration with air, DAkkS / ILAC - accredited calibration equipment D-K-15081-01-00 FMT power supply, housing for rail mounting 62.5 mm x 75 mm x 139 mm, input 230 V AC, output 24 V DC / 2.5 A	3KXS310130L1001 7962800
<b>FMT200-ECO2 small flange connections</b> FMT200-ECO2 process connections, ISO KF flange DN 25, for adapting inlet run and outlet run, incl. 2 clamp rings and 2 sealing rings FMT200-ECO2 process connections, inlet run section 10 x D, both sides with ISO KF flange DN 25 connection FMT200-ECO2 process connections, outlet run section 5 x D, both sides with ISO KF flange DN 25 connection FMT200-ECO2 process connections, clamping ring and gasket for ISO KF flange DN 25 connection FMT200-ECO2 process connections, tube adapter for KF DN 25, incl. small flange, 1 clamping ring and 1 sealing ring	7962850 7962801 7962802 7962809 7962803
<b>FMT200-ECO2 screwed connections and adapters</b> FMT200-ECO2 screwed connection G 3/8 in., pair for inlet run and outlet run, simultaneous connection for Legris tube adapter; inlet run adapter with high-tech flow straightener FMT200-ECO2 Legris tube adapter, 8 mm, pair for inlet run and outlet run FMT200-ECO2 Legris tube adapter, 10 mm, pair for inlet run and outlet run FMT200-ECO2 Legris tube adapter, 12 mm, pair for inlet run and outlet run FMT200-ECO2 Legris tube adapter, 14 mm, pair for inlet run and outlet run FMT200-ECO2 screwed connection G 3/4 in., pair for inlet run and outlet run, simultaneous connection for Transair system 25 mm; inlet run adapter with high-tech flow straightener FMT200-ECO2 Transair adapter, 25 mm, pair for inlet run and outlet run FMT200-ECO2 screwed connection G 1/2 in., pair for inlet run and outlet run FMT200-ECO2 screwed connection G 1 in., pair for inlet run and outlet run	7962851 7962855 7962856 7962857 7962858 7962853 7962812 7962852 7962854
<b>FMT200-ECO2 installation accessories</b> FMT200-ECO2 additional connection cable, 5 m with compact connector FMT200-ECO2 service and configuration box FMT200-ECO2 intermediate adapter, for connection cable eco 1 on FMT200-ECO2, length approx. 20 cm FMT200-ECO2 mounting adapter for DIN top-hat rail	7962817 7962818 7962819 7962816
<b>FMT200-ECO2 full set</b> FMT200-ECO2 full set, measuring kit FMT200-ECO2 with standard parameterization <b>Instructions for use</b> FMT200-ECO2 operating instruction, English FMT200-ECO2 operating instruction, German FMT200-ECO2 operating instruction, French FMT200-ECO2 operating instruction, Spanish	7962814 3KXF421004R4201 3KXF421004R4203 3KXF421004R4207 3KXF421004R4206

7 Questionnaire



**Questionnaire**  
**Thermal Mass Flowmeter**  
**Sensyflow FMT**

**Customer address:** \_\_\_\_\_  
 Company: \_\_\_\_\_  
 Zip code and location: \_\_\_\_\_  
 Cust. no.: \_\_\_\_\_  
 Contact person: \_\_\_\_\_

Date: \_\_\_\_\_  
 Telephone: \_\_\_\_\_  
 E-mail: \_\_\_\_\_

**Media data for gaseous, pure media:**

Description of media: \_\_\_\_\_ Mixed gas, gas composition in vol.%<sup>1)</sup>

Type of gas (no mixtures): \_\_\_\_\_ Component 1/name/vol. %: \_\_\_\_\_  
 Operating pressure (bar abs.) \_\_\_\_\_ Component 2/name/vol. %: \_\_\_\_\_  
 Min./norm./max., approx. \_\_\_\_\_ Component 3/name/vol. %: \_\_\_\_\_  
 Operating temperature (°C) \_\_\_\_\_ Component 4/name/vol. %: \_\_\_\_\_  
 Min./norm./max., approx. \_\_\_\_\_ Component 5/name/vol. %: \_\_\_\_\_

**Flowrate**<sup>2)</sup> Min.: \_\_\_\_\_ Norm.: \_\_\_\_\_ Max.: \_\_\_\_\_ **Pipeline/pipe component**<sup>3)</sup>

**Flow unit:**

	<i>Standard volume</i>	<i>Mass flow units</i>	DN/PN: _____
Nm <sup>3</sup> /h	<input type="checkbox"/>	kg/h	<input type="checkbox"/>
Nm <sup>3</sup> /min	<input type="checkbox"/>	kg/min	<input type="checkbox"/>
NI/min	<input type="checkbox"/>	g/min	<input type="checkbox"/>
SCFM	<input type="checkbox"/>	t/h	<input type="checkbox"/>
Other _____		Other _____	

°Standard condition, e.g., 0°C/1,013 mbar or \_\_\_\_\_

ANSI/lbs \_\_\_\_\_  
 Diameter [mm] \_\_\_\_\_  
Inside diameter specified in mm  
 Wafer flange form 1   
 Partial meas. section form 2   
 Weld-on adapter   
 Other \_\_\_\_\_

**Required device designs:**

FMT500-IG <input type="checkbox"/>	FMT700-P <sup>4)</sup> <input type="checkbox"/>	Integral mount design <input type="checkbox"/>
FMT400-VTS <input type="checkbox"/>	FMT200-ECO2 <input type="checkbox"/>	Remote design with
FMT400-VTCS <input type="checkbox"/>	FMT200-D <input type="checkbox"/>	Cable length 5 m <input type="checkbox"/>
		Cable length 15 m <input type="checkbox"/>
		Cable length 25 m <input type="checkbox"/>

**Output signal:** 0/4...20 mA   
 4...20 mA/HART   
 PROFIBUS DP-V1

**Ex protection class:** None   
 ATEX Zone 1/21   
 ATEX Zone 0/21

**Design:** Zone 2/22   
 GOST   
 FM/CSA

24 V   
 110 V   
 230 V

**Comments:**

---

1) Please specify the composition of mixed gases (e.g., North Sea natural gas: 1) CH<sub>4</sub> 90%, 2) C<sub>2</sub>H<sub>6</sub> 5%, 3) N<sub>2</sub> 3%, 4) C<sub>3</sub>H<sub>8</sub>, 1%, 5) CO<sub>2</sub> 1%).  
 2) Calibration is performed at the max. possible flow in the nominal size specified.  
 3) Please observe/determine the minimum inflow and outflow sections.  
 4) Output signal: 0...10 V as standard

**Note: An order can only be confirmed and a delivery date specified once full technical clearance has been obtained.**

Notes

Notes

---

Notes

# Contact us

## **ABB Ltd.**

### **Process Automation**

Oldends Lane, Stonehouse  
Gloucestershire, GL10 3TA  
UK

Tel: +44 (0)1453 826661

Fax: +44 (0)1453 829671

## **ABB Inc.**

### **Process Automation**

125 E. County Line Road  
Warminster PA 18974  
USA

Tel: +1 215 674 6000

Fax: +1 215 674 7183

measurement@us.abb.com

## **ABB Automation Products GmbH**

### **Process Automation**

Dransfelder Str. 2  
37079 Goettingen  
Germany

Tel: +49 551 905-534

Fax: +49 551 905-555

[www.abb.com](http://www.abb.com)

## Note

We reserve the right to make technical changes or modify the contents of this document without prior notice. With regard to purchase orders, the agreed particulars shall prevail. ABB does not accept any responsibility whatsoever for potential errors or possible lack of information in this document.

We reserve all rights in this document and in the subject matter and illustrations contained therein. Any reproduction, disclosure to third parties or utilization of its contents - in whole or in parts - is forbidden without prior written consent of ABB.

Copyright© 2012 ABB

All rights reserved

3KXF421004R1001

10/14-6.63-EN Rev. C.06.2012