

SensyTemp TSP300-W WirelessHART Temperature sensor with Energy Harvester

Measurement made easy



Short product description

Temperature sensor with Energy Harvester for the autonomous wireless measurement of the temperature of liquid and gaseous measuring media.

Further information

Additional documentation on SensyTemp TSP300-W WirelessHART is available for download free of charge at www.abb.com/temperature.

Manufacturer

ABB Automation Products GmbH

Process Automation

Schillerstr. 72

32425 Minden

Germany

Tel: +49 571 830-0

Fax: +49 571 830-1806

Customer service center

Tel.: +49 180 5 222 580

Fax: +49 621 381 931-29031

Mail: automation.service@de.abb.com

Contents

1	Safety.....	5	6	Installation	15
1.1	General information and instructions	5	6.1.1	Recommended insertion depth	15
1.2	Warnings	5	6.2	Opening and closing the housing	16
1.3	Intended use.....	5	6.2.1	Rotating the Antenna	16
1.4	Improper use	5	6.2.2	Rotating the LCD indicator.....	16
1.5	Handling of lithium ion batteries.....	5	6.3	Electrical connections	17
1.5.1	Transport.....	6	7	Commissioning.....	18
1.5.2	Disposal	6	7.1	General remarks	18
1.5.3	Battery lifetime.....	6	7.2	Checks prior to commissioning	18
1.6	Warranty provisions	6	7.3	Switching on the power supply	18
2	Use in potentially explosive atmospheres according to ATEX and IECEx.....	7	7.4	Basic Setup	18
2.1	Ex-marking Transmitter	7	7.4.1	Configuration with the LCD indicator	19
2.2	Installation instructions.....	7	7.4.2	Configuration with the PC / laptop or handheld terminal.....	20
2.3	Temperature data	7	7.4.3	Configuration with Device Type Manager (DTM) .	21
2.3.1	Model TSP341-W-A6 / H6-Y22 and Y23	8	7.4.4	Commissioning by Device Type Manager.....	21
2.3.2	TSP3x1-W (X=1-3) and TSP341-W-Y11 with Energy Harvester	8	7.4.5	Network Diagnostics by Device Type Manager ...	22
2.3.3	TSP3x1-W (X=1-3) and TSP341-W-Y11 without Energy Harvester	9	7.5	Operating instructions	22
2.3.4	Self heating of the sensor.....	9	8	Operation.....	22
2.4	Electrical connections	9	8.1	Activation of the LC display	22
2.5	Commissioning.....	9	8.2	Hardware settings.....	22
2.6	Operating instructions.....	9	8.3	Menu navigation	23
2.6.1	Protection against electrostatic discharges	9	8.4	Menu levels.....	23
2.6.2	Changing the measuring inset.....	9	8.4.1	Process display.....	24
2.6.3	Changing the battery	9	8.4.2	Switching to the information level (operator menu)	25
3	Function and System Design.....	10	8.4.3	Switching to the configuration level	25
3.1	Autonomous temperature measurement	10	8.4.4	Selecting and changing parameters	26
3.2	System structure	10	8.5	Overview of parameters on the configuration level	27
3.3	Input functionality.....	11	8.6	Parameter descriptions	29
3.3.1	Sensor redundancy.....	11	8.6.1	Menu: Device Setup.....	29
3.3.2	Sensor drift monitoring.....	11	8.6.2	Menu: Device Info.	30
3.3.3	Sensor error adjustment using Callendar-Van Dusen coefficients	12	8.6.3	Menu: Communication.....	31
3.4	Wireless HART Capabilities	12	8.6.4	Menu: Service.....	32
3.5	Types of temperature sensor – overview	13	8.6.5	Menu: Display.....	33
4	Product identification.....	14	8.6.6	Menu: Calibrate	33
4.1	Name plate.....	14	9	Diagnosis / error messages	34
5	Transport and storage	14	9.1	Diagnostic information	34
5.1	Inspection.....	14	9.1.1	Monitoring of operating values	34
5.2	Transporting the device	14	9.1.2	Operating hours statistics.....	34
5.3	Storing the device.....	14	9.2	Calling up the error description.....	34
5.3.1	Ambient conditions	14	9.3	Possible error messages.....	35
5.4	Returning devices	14	10	Maintenance.....	36
			10.1	Cleaning	36
			10.2	Replacing the battery	36

11	Repair	37
11.1	Changing the measuring inset.....	37
11.2	Returning devices	37
12	Recycling and disposal.....	38
12.1	Disposal	38
12.2	Information on ROHS Directive 2011/65/EC.....	38
13	Spare parts, consumables and accessories	38
14	Specifications.....	38
15	Appendix	39
15.1	Return form	39
15.2	Declarations of conformity.....	40

1 Safety

1.1 General information and instructions

These instructions are an important part of the product and must be retained for future reference.

Installation, commissioning, and maintenance of the product may only be performed by trained specialist personnel who have been authorized by the plant operator accordingly. The specialist personnel must have read and understood the manual and must comply with its instructions.

For additional information or if specific problems occur that are not discussed in these instructions, contact the manufacturer.

The content of these instructions is neither part of nor an amendment to any previous or existing agreement, promise or legal relationship.

Modifications and repairs to the product may only be performed if expressly permitted by these instructions.

Information and symbols on the product must be observed.

These may not be removed and must be fully legible at all times.

The operating company must strictly observe the applicable national regulations relating to the installation, function testing, repair and maintenance of electrical products.

1.2 Warnings

The warnings in these instructions are structured as follows:

DANGER

The signal word "DANGER" indicates an imminent danger. Failure to observe this information will result in death or severe injury.

WARNING

The signal word "WARNING" indicates an imminent danger. Failure to observe this information may result in death or severe injury.

CAUTION

The signal word "CAUTION" indicates an imminent danger. Failure to observe this information may result in minor or moderate injury.

NOTE

The signal word "NOTE" indicates useful or important information about the product.

The signal word "NOTE" is not a signal word indicating a danger to personnel. The signal word "NOTE" can also refer to material damage.

1.3 Intended use

This device is intended for the following uses:

- To measure the temperature of fluid, pulpy or pasty substances and gases or resistance/voltage values.

The device has been designed for use exclusively within the values stated on the name plate and within the technical limit values specified on the data sheets.

- The maximum and minimum operating temperature limits must not be exceeded or undershot.
- The permissible ambient temperature must not be exceeded.
- The housing's degree of protection must be observed during operation.

1.4 Improper use

The following are considered to be instances of improper use of the device:

- As a climbing aid, e.g., for mounting purposes.
- As a support for external loads, e.g., as a support for piping, etc.
- Adding material, e.g., by painting over the name plate or welding / soldering on parts.
- Removing material, e.g., by spot drilling the housing.

1.5 Handling of lithium ion batteries

Lithium batteries do not pose a danger if handled properly.

Please note the following points for the proper handling of lithium batteries:

- Protect the contacts or connection leads of lithium batteries that are not used in the device against short-circuits, e.g. by masking them
- Do not charge lithium batteries

1.5.1 Transport

The device is shipped with a Lithium Battery in shape of a D-Cell. The battery is already installed.

Transport of lithium batteries is subject to regulations.

Regulations are based on the United Nations Model Regulations on the Transport of Dangerous Goods.

The most important regulations can be summarized as follows:

- C- and D-size cells as well as larger cells and most battery packs have to be transported under dangerous goods regulations.
- Lithium batteries below 2 g lithium content (corresponding approximately to 3 AA cells) are exempted from dangerous goods regulations but each package requires a special label to indicate that it contains lithium batteries and special procedures shall be followed when a package is damaged during transportation.
- Transport regulations require that lithium cells and batteries of all kinds, exempted or not, be tested according to the UN test methods.

Packing instructions for air transport of lithium batteries worldwide are revised biennially by the International Civil Aviation Organization (ICAO) and distributed in various languages by the International Air Transport Association (IATA).

According to the regulations, Tadiran Lithium Batteries are classified as lithium metal batteries. Different regulations are valid for transport in the USA.

1.5.2 Disposal

The European Battery Directive 2006/66/EC restricts the use of certain hazardous substances in batteries and establishes rules for the collection, treatment, recycling and disposal of waste batteries and accumulators.

It is transposed individually in each EU member state. For example, transposition in the UK is by the Batteries and Accumulators (Placing on the Market) Regulations 2008 and by the Waste Batteries and Accumulators Regulations 2009.

The following information is important for end users of batteries:

- Batteries are marked with the crossed-out wheeled bin symbol (see title bar). The symbol reminds end users that batteries must not be disposed as municipal waste, but collected separately. Used batteries can be returned at the point of sale at no charge.

- The reason for these regulations is that there are a number of environmental concerns which arise when dealing with the waste management of batteries and accumulators. These relate for the most part to the metals contained in these batteries. Mercury, lead and cadmium are by far the most problematic substances in the battery waste stream. Other metals commonly used in batteries, such as zinc, copper, manganese, lithium and nickel, may also constitute environmental hazards. However, the new regulations apply to all batteries and not just to hazardous ones because all batteries contain substances which are more or less harmful to the environment and because experience with previous regulations showed that 'all battery' collection schemes are more efficient than separate schemes for certain types of portable batteries.
- Batteries should be recycled because battery recycling helps to save resources by allowing for the recovery of valuable metals such as nickel, cobalt and silver and requires less energy consumption. For example, using recycled cadmium and nickel requires respectively 46 % and 75 % less primary energy than the extraction and refining of virgin metals.

This information is based on the 'Q&A on the Batteries Directive 2006/66/EC' document that can be downloaded from the European Commission website.

1.5.3 Battery lifetime

The SensyTemp TSP300-W support battery management by a life time estimation algorithm. There are parameters outside the device's control influencing the battery life time such as operating temperature.

The SensyTemp TSP300-W estimates remaining battery life time based on current consumption and electronics temperature. Anyway it is a calculation based on historical information and does not consider future conditions. When the battery is changed, the transmitter powers down. Insertion of a new battery has to be notified to the device via EDD, DTM or LC display locally.

1.6 Warranty provisions

Using the device in a manner that does not fall within the scope of its intended use, disregarding this manual, using underqualified personnel, or making unauthorized alterations releases the manufacturer from liability for any resulting damage. This renders the manufacturer's warranty null and void.

2 Use in potentially explosive atmospheres according to ATEX and IECEx

i NOTE

For further information on the approval of devices for use in potentially explosive atmospheres, refer to the explosion protection test certificates (available on the accompanying product CD or at www.abb.com/temperature).

2.1 Ex-marking Transmitter

i NOTE

- Depending on the design, a specific marking in accordance with ATEX or IECEx applies.
- ABB reserves the right to modify the Ex-marking. Refer to the name plate for the exact marking.

Model TSP3x1-W-A6..., TSP3x1-W-H6...
(Sensor with transmitter in zone 0, 1, or 2)

ATEX	IECEx
II 1 G Ex ia IIC T4...T1 Ga	Ex ia IIC T4...T1 Ga
Certificate no.: PTB 14 ATEX 2010X	Certificate no.: In preparation

- The transmitter and the connected temperature sensor may be used complete in zone 0, zone 1 or zone 2
- The temperature range corresponds to the information in chapter

The device is supplied with or without an LCD indicator (order option "Housing / Indicators").

The LCD indicator has been awarded the following certificates:

ATEX	IECEx
Certificate no.: PTB 05 ATEX 2079X	Certificate no.: IECEx PTB 12.0028X

2.2 Installation instructions

The installation, commissioning, maintenance and repair of devices in areas with explosion hazard must only be carried out by appropriately trained personnel.

When operating the meter in the presence of combustible dusts, IEC 61241 ff must be complied with.

The safety instructions for electrical apparatus in potentially explosive areas must be complied with, in accordance with Directive 94/9/EC (ATEX) and IEC60079-14 (Installation of electrical equipment in potentially explosive areas).

To ensure safe operation, the requirements of EU Directive ATEX 118a (minimum requirements concerning the protection of workers) must be met.

When installing in potentially explosive atmospheres, please observe the following points:

- The specifications of IEC 60079-14 must be observed.
- Damaged equipment/components must not be used.
- Installation may only be carried out in atmospheres that are not potentially explosive.
- The device is not suitable for mobile use.
- Adequate cooling or air circulation must be ensured at the installation site in order to comply with the maximum permissible ambient temperature T_{ambient} .
- To ensure compliance with the Ex i (intrinsic safety) type of protection, the housing must meet IP rating IP 20 as a minimum after installation.
- Devices, which contain Aluminum (TSP3X1-W with connection heads L2 and L4 or transmitter W3 or sensor mounting Y11), must be protected against mechanical impact, when installed in hazardous areas where devices with equipment protection level EPL Ga are required.

2.3 Temperature data

For all TSP3x1-W versions there are two relevant parts of the Sensor with different temperature ranges:

1. At the enclosure of the transmitter the temperatures must be in the range of -40 °C up to 70 °C.
2. The process temperature at the measuring point could be different, but the influence of the self-heating from the sensor, the temperature rise in the electronic and the temperature class/zone has to be taken into account.

2.3.1 Model TSP341-W-A6 / H6-Y22 and Y23

The TSP341-W xx Y22 and Y23 (...) can be used at ambient temperatures from -40°C up to 70 °C at the transmitter enclosure and the maximum process temperature for each temperature class and each individual setup has to be defined with respect to the maximum of 70 °C at the electronic and the self-heating of the sensor element above.

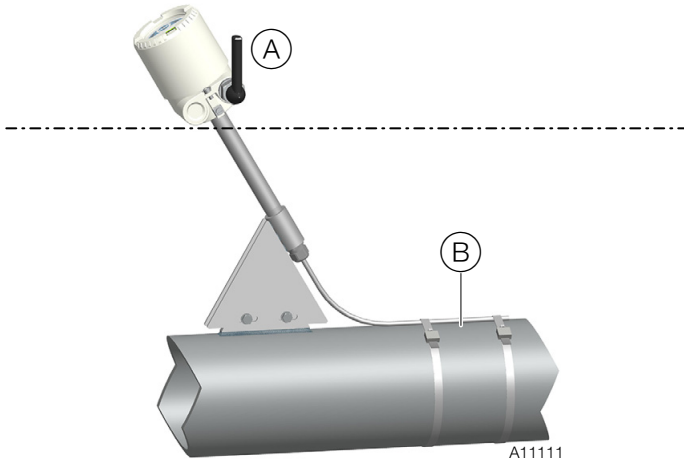

Fig. 1: Sensor mounting alongside the piping

Position	Temperature
(A)	T_{ambient} : -40 °C ... 70 °C
(B)	Surface temperature: Temperature class reduced by selfheating of the Sensor

2.3.2 TSP3x1-W (X=1-3) and TSP341-W-Y11 with Energy Harvester

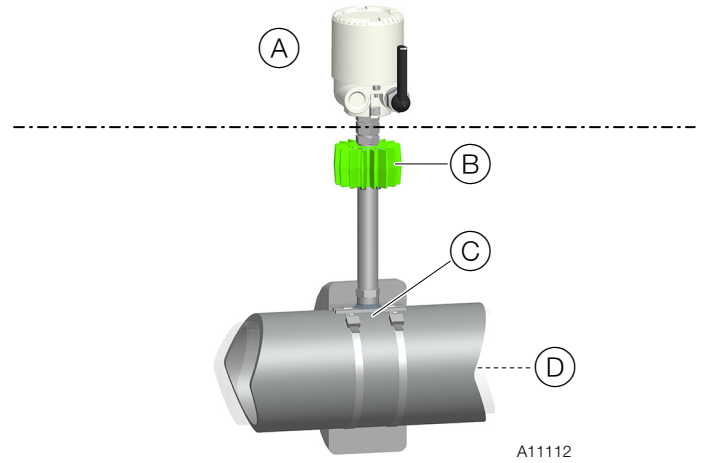

Fig. 2: Sensor mounting 90° to the piping with Energy Harvester

Position	Temperature
(A)	T_{ambient} : -40 °C ... 70 °C
(B)	<ul style="list-style-type: none"> – The Energy Harvester can be used in the temperature range of -40 °C to +150 °C. – For intrinsic safety maximum temperature delta at the Energy Harvester of 150 K is allowed
(C)	TEG unit used: Maximum surface temperature 150 °C
(D)	T_{process} : -40 °C ... 150 °C

2.3.3 TSP3x1-W (X=1-3) and TSP341-W-Y11 without Energy Harvester

No zone, zone 0, zone 1 or zone 2

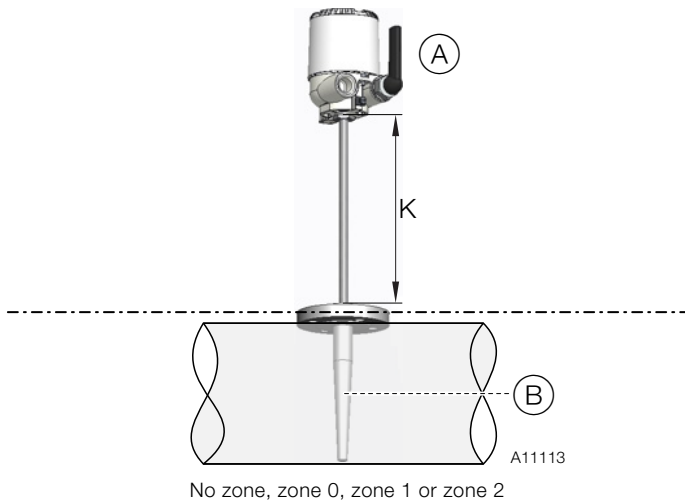

Fig. 3: Sensor with extension tube
K Extension tube length

Position	Temperature
(A)	Temperature region for the electronic: -40 °C ... 70 °C Maximum T_{ambient} : 70 °C – heating due the process temperature
(B)	Maximum T_{process} : Temperature class reduced by selfheating of the sensor

For TSP3x1-W (X:1-3) and TSP 341-W-xx-Y11 without Energy Harvester the use for the different temperature classes depends on the process temperature and the zone definition. The transmitter enclosure must not be heating up higher than 70°C.

Depending on the extension tube length "K" and the process temperature the enclosure for the transmitter will heat up so the ambient temperature has to be reduces for such cases. The following table shows the T_{ambient} for TSP3x1-W at different process temperature. A protection against radiation heat has to be realized. (For example: isolation with 25mm thickness around the process enclosure.)

T_{process}	T_{ambient} for extension tube length K = 150 mm	T_{ambient} for extension tube length K = 250 mm
100 °C	Max. 65 °C	Max. 70 °C
200 °C	Max. 60 °C	Max. 70 °C
300 °C	Max. 60 °C	Max. 70 °C
400 °C	Max. 55 °C	Max. 65 °C

2.3.4 Self heating of the sensor

The self heating of the sensor is generally defined. The attached tables take these values into account and show the resulting maximum process temperature for the different temperature classes for each configuration of the TSP3x1-W

Ex-Zone	T4 135 °C (-5 K)	T3 200 °C (-5 K)	T2 (300 °C) (-10 K)	T1 400 °C (-10 K)
Zone 1	123 °C	188 °C	283 °C	383 °C
Zone 0	96 °C	148 °C	223 °C	303 °C

Zone 0 with consideration of EN1127-1.

2.4 Electrical connections HART maintenance port

	HART maintenance port on TTF300-W	Maximum external connection values
Maximum voltage	$U_o = 5.4 \text{ V}$	$U_i = 2.6 \text{ V}$
Short-circuit current	$I_o = 25 \text{ mA}$	$I_i = 18 \text{ mA}$
Maximum power	$P_o = 34 \text{ mW}$	–
Inductance	$L_i = 0 \text{ mH}$	$L_o = 1 \text{ mH (IIC)}$
Capacitance	$C_i = 1.2 \text{ }\mu\text{F}$	$C_o = 0.4 \text{ }\mu\text{F (IIC)}$

2.5 Commissioning

The commissioning and parameterization of the device may also be carried out in potentially explosive atmospheres using a handheld terminal that has been approved accordingly. The handheld terminal is connected to the internal HART maintenance port of the device (see „Fig. 14“ on page 18). The values specified in chapter „Electrical connections“ on page 9 must be adhered to.

2.6 Operating instructions

2.6.1 Protection against electrostatic discharges

The plastic parts inside the device can store electrostatic charges. Make sure that no electrostatic charges can accumulate when handling the device.

2.6.2 Changing the measuring inset

Changing of the measuring inset may only be carried out in atmospheres that are not potentially explosive. Change the measuring inset in accordance with chapter „Changing the measuring inset“ on page 37.

2.6.3 Changing the battery

When changing the device battery, observe the following points:

- The battery can be replaced in potentially explosive atmospheres because all circuits in the device are intrinsically safe
- The battery must not be short-circuited
- The provisions of the relevant operational safety regulations must be observed
- Take appropriate measures to prevent electrostatic charges on the plastic sleeve of the battery

Change the battery in accordance with chapter „Replacing the battery“ on page 36.

3 Function and System Design

3.1 Autonomous temperature measurement

In the past, temperature measurement devices always required cables to supply power and transmit signals. The cabling was often very laborious, taking up a lot of time and incurring high costs, particularly if larger distances had to be covered, disturbances circumvented, and safety aspects considered.

The costs for the cabling often exceeded the costs of the measuring device itself, which ultimately led to temperatures not being measured at all. This meant accepting compromises in terms of optimum process control.

The introduction of wireless signal transmission brought about a reduction in the costs of cabling. Nevertheless, a cable connection was still required to supply power to the measuring device.

Battery operation is a possible alternative. However, maintenance intervals for battery replacement must be strictly observed to guarantee fully functioning measurement.

The SensyTemp TSP300-W temperature sensors enable completely independent temperature measurement. There is no longer any need for cabling or battery replacement, and installation and maintenance costs are drastically reduced or even eliminated completely. No additional external energy is needed, and ensuring compliance with safety requirements is much easier. The result is an increase in system performance, improved effectiveness, and increased safety.



Fig. 4

3.2 System structure

TSP temperature sensors are contact thermometers which, through contact with the measuring medium, are brought to the temperature of the medium.

The sensor is made up of modular components. The centerpiece is the measuring inset, which houses the actual sensor element for temperature measurement in its tip. The thermowell surrounds the measuring inset and establishes the contact to the measuring medium. It ensures that the measuring inset can be replaced in a self-contained process and protects the inset against mechanical and corrosive influences of the process. The material and geometry of the thermowell must meet the process requirements (e.g. medium composition, measuring temperature, pressure).

The process connection is the mechanical interface between the process and the temperature sensor. The extension tube mounted on this interface creates the required distance to the connection head to protect it against overheating. The temperature gradient between the process temperature and the ambient temperature in the extension tube is converted into electrical energy by an Energy Harvester. An integrated micro-thermal generator (micro TEG) supplies the power for this. The electrical energy required is generated from the temperature difference between the process pipe and the ambient temperature by applying the Peltier effect. The micro TEG is therefore the ideal solution for using wireless WirelessHART temperature sensors as completely autonomous units in most processes. Many processes involve sufficient process heat to enable a "complete power supply" by the micro TEG. A built-in high-performance battery buffers potential process-driven power failures of the micro TEG. The adjustable connection head houses the transmitter electronics that convert the small output signal from the sensor elements into a WirelessHART signal.

SensyTemp TSP300-W temperature sensors are communication-ready devices with microprocessor-controlled electronics.

With wired HART transmitters, an FSK signal is superimposed on the 4 ... 20 mA output signal in accordance with the HART standard to facilitate bidirectional communication.

Wireless HART transmitters provide an FSK maintenance port too, compatible with existing tools such as modems and handheld terminals with the purpose of configuration and maintenance.

Anyway, its main communication interface is wireless. The same protocol is used to communicate with a wireless HART compatible gateway. The gateway provides different kinds of wired interfaces and protocols such as RS-485 or Ethernet. The transmitters can be configured, polled, and tested using a DTM or an EDD via both, the wired and the wireless interface.



Fig. 5
① SensyTemp TSP300-W ② Processing pipe

3.3 Input functionality

3.3.1 Sensor redundancy

To enhance system availability, the SensyTemp TSP300-W has two sensor inputs for a measuring insert with two sensors. The second sensor input can be used redundantly for both resistance thermometers (2 x three-wire circuit or 2 x two-wire circuit) and thermocouples, or for a mixture of the two. Sensor redundancy (or sensor backup) always involves measuring the temperature of the two sensors and calculating the mean value on the basis of this. This value is provided at the output of the transmitter. Should a sensor fail, the temperature measurement for the sensor that remains in operation is provided at the output of the transmitter.

A relevant diagnostic message is provided via the EDD or DTM, or shown on the display. The measured value remains available and maintenance measures can be taken at the same time.

3.3.2 Sensor drift monitoring

When two sensors are connected, sensor drift monitoring can be activated via the EDD or DTM.

It can be activated for the following two sensor types:

- 2 x resistance thermometer (RTD), two-wire circuit
- 2 x resistance thermometer (RTD), three-wire circuit
- 2 x resistor (potentiometer), two-wire circuit
- 2 x resistor (potentiometer), three-wire circuit
- 2 x thermocouple
- 2 x voltage
- 1 x resistance thermometer (RTD), two-wire circuit and 1 x thermocouple
- 1 x resistance thermometer (RTD), three-wire circuit and 1 x thermocouple
- 1x resistance thermometer (RTD), four-wire circuit and 1 x thermocouple

To activate sensor drift monitoring, the transmitter must first be configured for the sensor types referred to above.

Following this, the maximum permissible sensor deviation must be configured, e.g., 1 K.

Since sensor response times may differ slightly, it is then necessary to configure a limit time period during which the sensor deviation has to constantly exceed the maximum set. If the transmitter records a larger sensor deviation during the defined time period, a HART, EDD, and DTM diagnostic notification - "Maintenance required" - is generated according to NE 107. At the same time, diagnostic information is shown on the LCD indicator.

If drift monitoring is used for equivalent sensors (2 x Pt100 or 2 x thermocouple), the mean value calculated from the two sensors is mapped to the transmitter's output signal as a process variable in redundancy mode.

If a thermocouple is used for Pt100 drift monitoring, the Pt100 sensor (see Chapter „Electrical connections“ on page 17) must be connected to channel 1 and the thermocouple to channel 2.

The measured value from channel 1 (Pt100) is mapped to the transmitter output as a process variable.

i NOTE

Before configuring the maximum permissible sensor deviation for drift monitoring, sensor adjustment with respect to the sensor channel 1 value must be carried out with the help of the SensyTemp TSP300-W DTM or EDD.

3.3.3 Sensor error adjustment using Callendar-Van Dusen coefficients

Under normal circumstances, the standard Pt100 characteristic curve is used for resistance thermometer measurement.



However, recent advances in technology now mean that maximum measuring accuracy can be achieved where necessary by carrying out individual sensor error adjustment. Sensor characteristic curves are optimized by using a Pt100 polynomial in accordance with IST-90 / IEC 751, and EN 60150, and by applying A, B, C, or Callendar-Van Dusen coefficients.

The DTM or EDD can be used to set and store these sensor coefficients (Callendar-Van Dusen) in the transmitter as a CVD characteristic curve. Up to five different CVD characteristic curves can be stored.

3.4 Wireless HART Capabilities

- Wireless Interface
- Burst Mode
- Wired Interface (HART maintenance port)

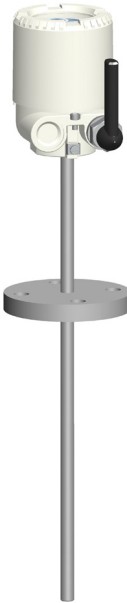
3.5 Types of temperature sensor – overview

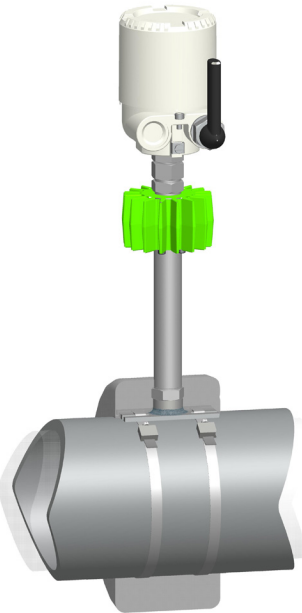
Type	TSP311-W	TSP321-W	TSP331-W	TSP341-W
	 A11052	 A11053	 A11054	 A11055
Energy Harvester	●	—	●	●
LCD display	●	●	●	●
Design	Measuring inset, thermowell, extension tube with thermowell connection, process connection, connection head, WirelessHART electronics-			
Process connection	For installation in an existing thermowell	Screw-in thread, flange, weld-in socket, compression fitting	Screw-in thread, flange, weld-in socket	Surface mounting
Thermowell	None	Welded	Drilled	None

4 Product identification

4.1 Name plate

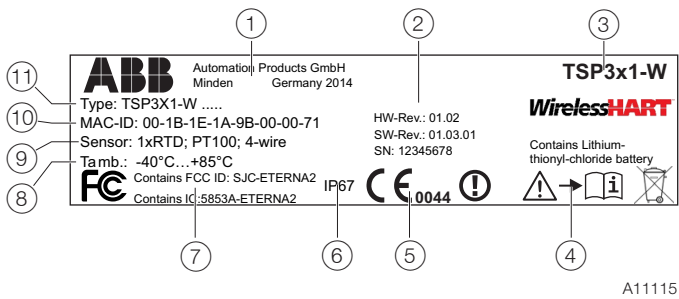

A11115

Fig. 6: Name plate (example)

- ① Device manufacturer, country and year of production
- ② Hardware /software version and device serial number
- ③ Type designator ④ Refer to product documentation
- ⑤ CE mark (EC conformity) ^{1) 2)} ⑥ IP rating (housing)
- ⑦ Spectrum certificate ⑧ Ambient temperature range
- ⑨ Sensor type ⑩ MAC-ID (unique network address)
- ⑪ Device ordering code

- 1) The marking of the notified body (0044) does not apply to the non-Ex version.
- 2) The CE mark and the exclamation mark in a circle does not apply to the IECEx version.

Devices with an explosion-proof design are marked with the following special data plate.

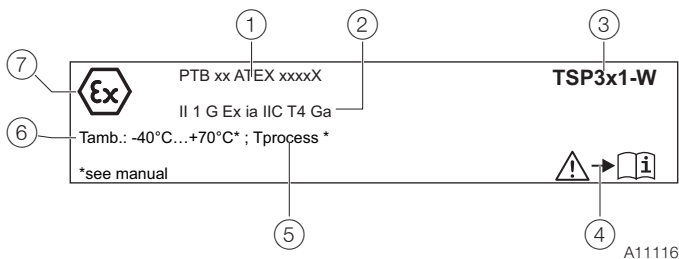

A11116

Fig. 7: Special data plate for explosion-protected apparatus (example)

- ① Ex certificate ② Ex-marking ③ Type designation
- ④ Observe product documentation ⑤ Process temperature
- ⑥ Ambient temperature range ⑦ "Explosion protection" symbol

i NOTE



Products that are marked with this symbol may not be disposed of through municipal garbage collection points.

5 Transport and storage

5.1 Inspection

Check the devices immediately after unpacking for possible damage that may have occurred from improper transport. Details of any damage that has occurred in transit must be recorded on the transport documents.

All claims for damages must be submitted to the shipper without delay and before installation.

5.2 Transporting the device

Observe the following information:

- Do not expose the device to moisture during transport. Pack the device accordingly.
- Pack the device so that it is protected from vibration during transport, e.g. through air-cushioned packaging.

⚠ CAUTION

Corrosion, fire and explosion hazard if lithium batteries are not properly handled.

Lithium batteries contain acids and may explode if they are exposed to extreme heat, become mechanically damaged or are electrically overloaded.

- Never charge or short-circuit lithium batteries
- Never expose lithium batteries to temperatures > 100 °C (> 212 °F) or to fire
- Never use damaged lithium batteries

For detailed information about handling lithium batteries, see chapter „Handling of lithium ion batteries“ on page 5.

5.3 Storing the device

Bear the following points in mind when storing devices:

- Store the device in its original packaging in a dry and dust-free location.
- Observe the permitted ambient conditions for transport and storage.
- Avoid storing the device in direct sunlight.
- In principle, the devices may be stored for an unlimited period. However, the warranty conditions stipulated in the order confirmation of the supplier apply.

5.3.1 Ambient conditions

The ambient conditions for the transport and storage of the device correspond to the ambient conditions for operation of the device.

Adhere to the device data sheet!

5.4 Returning devices

For the return of devices, follow the instructions in the chapter „Repair“ on page 37.

6 Installation

General Information

As contact thermometers have to be brought to the temperature of the measuring medium, correct installation is particularly important for the quality of the measurement. The best results with regard to accuracy and response time are achieved when the sensor element is located at the point of the greatest medium velocity, i.e. the center of the pipe. To eliminate heat conduction errors to the greatest extent possible, the immersion length must be 10 ... 15 times the thermowell diameter. -Heat conduction errors arise when the ambient temperature reaches the sensor element via the thermowell.

The sensor built in to the tip of the thermowell should be as evenly bathed in medium as possible.

Installation positions 2 and 3: The thermowells are therefore usually installed at a 90° angle. -The thermowell tip, i.e. the sensor, should be in the middle of the pipe.

Installation positions 1 and 5: To meet the requirement for central installation of the sensor, thermowells can also be installed in elbow pipes vertically or at an obtuse angle to the flow direction.

Installation position 4: Indirect measurement of the medium temperature via the pipe surface is a further option in addition to immersion measurement. Indirect measurement is somewhat less accurate than measurement in the pipe. Pipe wall thickness, pipe material and other parameters can influence the measuring result.

For surface measurement, ensure optimum contact between the sensor element and the surface and that the sensor element is insulated against the ambient temperature by means of suitable insulating material.

In conjunction with an Energy Harvester, the temperature sensor is completely location-independent within its range in this measuring method as neither wiring nor difficult to install welded spuds are required.

6.1.1 Recommended insertion depth

To avoid heat dissipation errors.

Medium	Insertion depth [mm]
Fluids	8 ... 10 x Ø thermowell tip
Gases	10 ... 15 x Ø thermowell tip

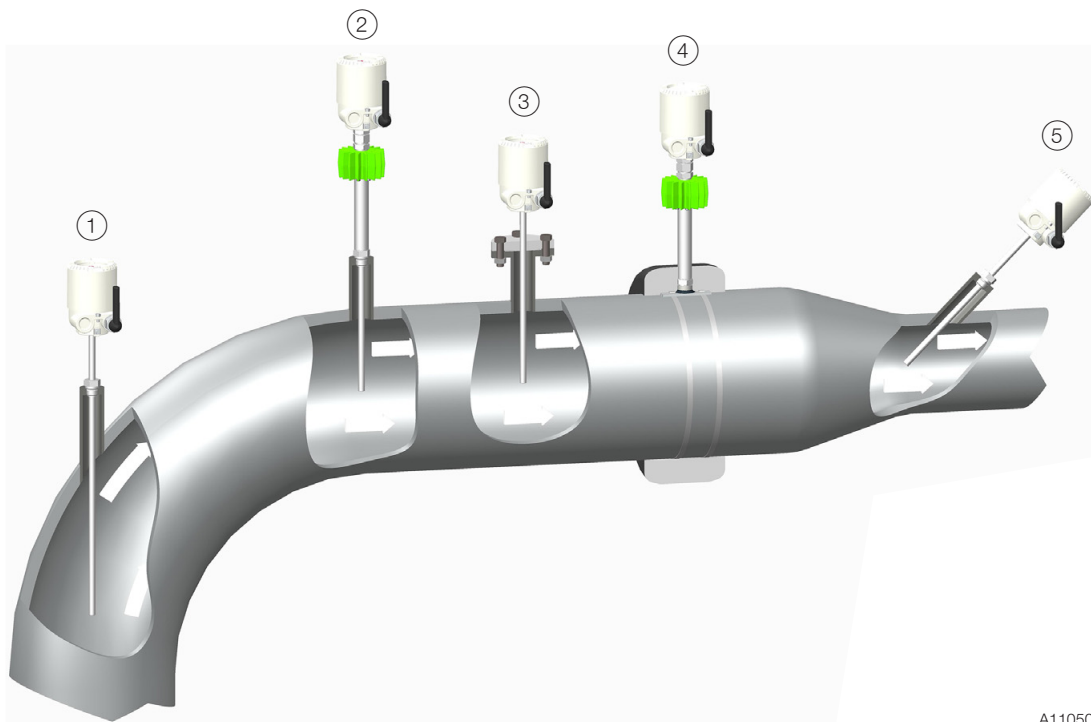
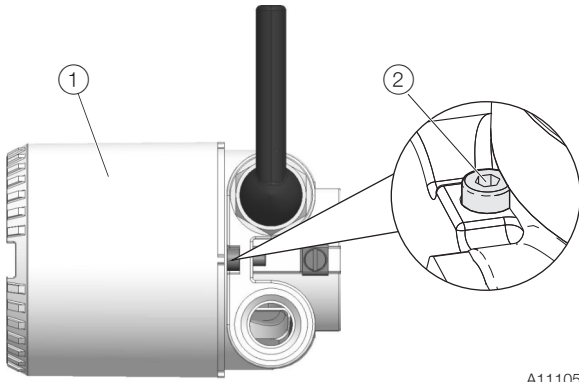

Fig. 8: Installation positions

A11050

6.2 Opening and closing the housing



A11105

Fig. 9: Cover safety device (example)

Open the housing

1. Release the cover safety device by screwing in the Allen screw (2).
2. Release the housing cover (1).

Closing the housing

i NOTE

Impairment of the housing protection class

Check the O-ring gasket for damage and replace it if necessary before closing the housing cover.

Check that the O-ring gasket is properly seated when closing the housing cover.

1. Screw the housing cover (1) back on.
2. Lock the housing cover by unscrewing the Allen screw (2).

6.2.1 Rotating the Antenna

Usually the antenna should be turned into a vertical position by unlocking the screw at the TSP300-W housing.

i NOTE

The Antenna must not be rotated more than 360° in order to not damage the HF wire inside the transmitter.

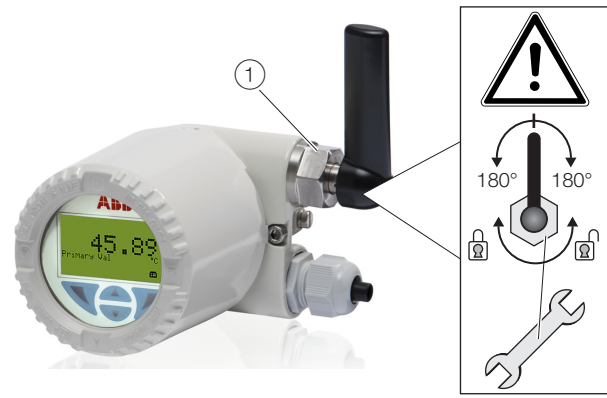

A11108

Fig. 10: Rotate the Antenna

- (1) Lock screw

6.2.2 Rotating the LCD indicator

Depending on the mounting position, the LCD indicator can be rotated to enable horizontal readings.

There are 4 possible positions at increments of 90°.

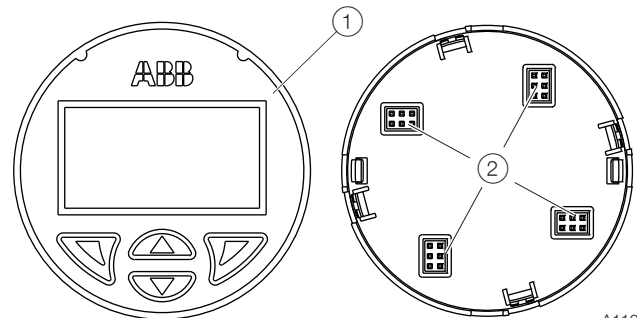

A11094

Fig. 11

- (1) Front view
- (2) Rear view of LCD indicator/plug positions

To adjust the position, proceed as follows:

1. Unscrew the housing cover.
2. Carefully pull the LCD indicator to release it from its bracket.
3. Carefully insert the LCD indicator in the required position.
4. Screw the housing cover back on.

i NOTE

If the O-ring gasket is seated incorrectly or is damaged, this may have an adverse effect on the IP rating.

Check the O-ring gasket for damage and replace it if necessary before closing the housing cover.

Check that the O-ring gasket is properly seated when closing the housing cover.

6.3 Electrical connections

Resistance thermometers (RTD) / resistors (potentiometers)

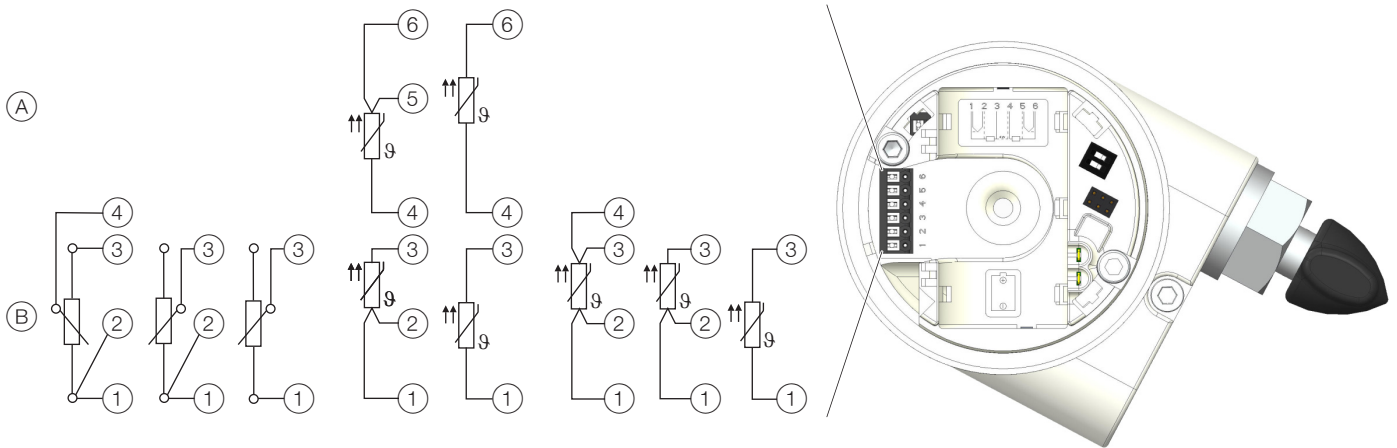

A11106

Fig. 12

① – ⑥ Sensor connection (from measuring inset) (A) Sensor 1 (B) Sensor 2

Thermocouples / voltages and resistance thermometer (RTD) / thermocouple combinations

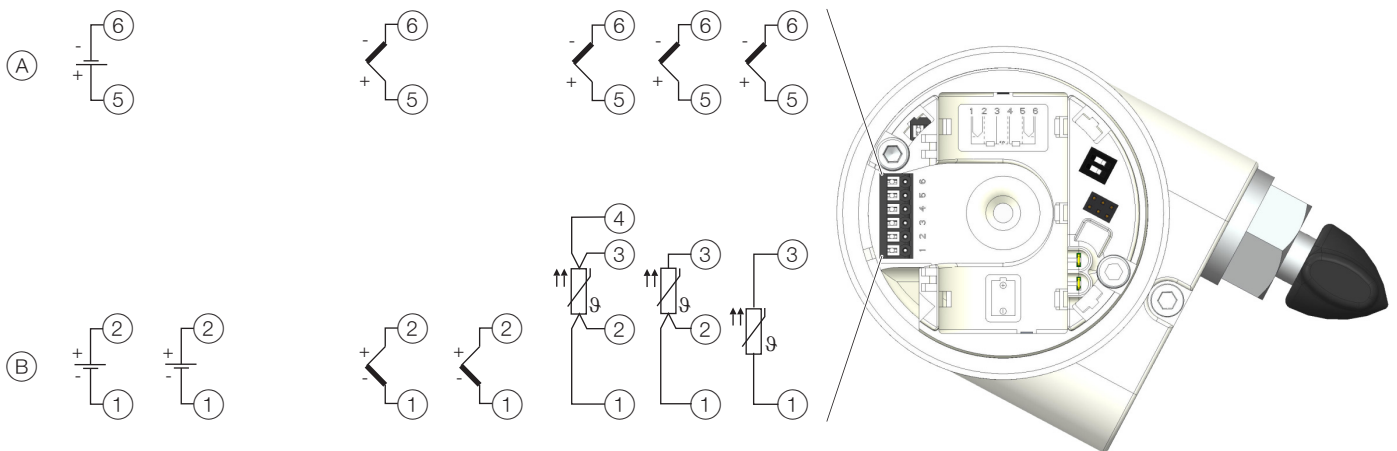

A11107

Fig. 13

① – ⑥ Sensor connection (from measuring inset) (A) Sensor 1 (B) Sensor 2

7 Commissioning

7.1 General remarks

The device is immediately ready for operation after mounting and installation of the connections. Default parameters are set at the factory.

7.2 Checks prior to commissioning

The following points must be checked before commissioning the device:

- The ambient conditions must meet the requirements set out on the name plate and in the Datasheet.

7.3 Switching on the power supply

For initial shipment the device's battery is isolated by plastic tap. With removal of the tap the device gets powered. To power-off the device insert an isolating tap between the battery and one of the poles or remove the battery.

7.4 Basic Setup

The SensyTemp TSP300-W can be commissioned via the build in LCD indicator (see Chapter „Configuration with the LCD indicator“ on page 19).

Additionally the SensyTemp TSP300-W can be commissioned via standard HART tools including:

- ABB HART Hand Held DHH805 (TTX300-W EDD).
- ABB Asset Vision Basic (TTX300-W DTM).
- ABB 800xA Control System (TTX300-W DTM)
- Other tools supporting standard HART EDDs or DTMs (FDT1.2)

i NOTE

Not all tools and frame applications do support DTMs or EDDs on same level. Particularly optional or extended functions of the EDD/DTM may not be available on all tools. ABB provides frame applications supporting full range of functions and performance.

The connection to these tools can be both, wired or wireless. For first commissioning the wired connection should be preferred. The HART maintenance port is the interface for the wired connection.

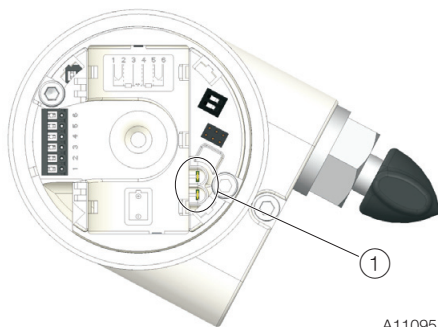

A11095

Fig. 14 : Wired connection

① HART maintenance port (hand-held terminal)

Usually 3 parameters should be set always during first commissioning to allow a device to join a network.

Network-ID

The network-id is the identifier of a network and must be the same for all devices within the same network including the gateway.

There might be other networks in parallel but they need to have a different network-id.

The network ID is a 16 bit wide number.

Join-Key

The join key is important to authorize a device joining the network. It serves for network security. The join key can be the same for different networks.

The join key is a security relevant information and should be protected as such. Wireless HART allows individual join keys for the wireless devices in the network what serves for higher security but has also impact on maintenance effort.

Not all gateways may support individual join keys. The join key is a set of four 32 bit wide numbers (128 bit in total).

i NOTE

For security reasons the join key can not read back from the device, also not via the local LC display

HART Long-TAG

This is human readable identifier of the device in the network and is almost used by a gateway to build a device list ("live list") of the network.

The long TAG shall be unique for every device in the network. Some gateways notify when doubled long TAGs are identified. As the long TAG is 32 characters long it is suitable to serve as a unique identifier of a single device in a whole plant / installations and not just within the wireless HART network. By default, the SensyTemp TSP300-W is delivered with a unique long TAG containing part of the devices serial number and therefore there is no need to set the long TAG.

In case network ID and join key of SensyTemp TSP300-W already match the settings of the gateway e.g. due to prior configuration or default settings are used, there is no need for any further adjustments. The SensyTemp TSP300-W will join a reachable network automatically.

7.4.1 Configuration with the LCD indicator

Commissioning via LC display does not require any tools connected to the device and is therefore the easiest way to get a SensyTemp TSP300-W into a wireless network. The general operation and menus of the LCD indicator are described in chapter „Menu navigation“ on page 23. The relevant parameters for network settings are part of menu “Communication”.

Enter the following parameters as described:

1. Activate the LCD indicator.

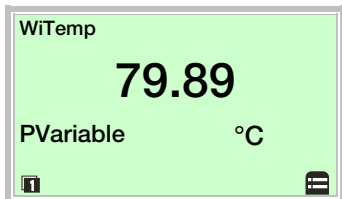

2. Use to switch to the configuration level.



3. Use or to select "Communication".
4. Use to confirm your selection.

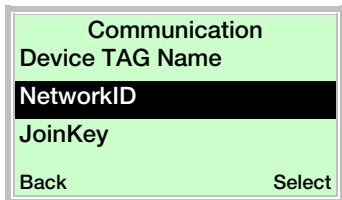

5. Use or to select "NetworkID".
6. Use to confirm your selection.

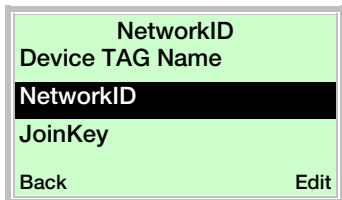

7. Use to call up the edit mode.
8. Enter the desired Network ID.
9. Use to confirm your setting.



10. Use or to select "JoinKey".
11. Use to confirm your selection.



The four numbers of the join key are again separated as 8 single hexadecimal characters 0 ... 9 + A ... F. The hexadecimal characters are set individually, one by one by using the up and down button to select a hexadecimal character. As the join key can not read back for security reasons the selected character after entering the sub menu is “8” always.

Join key (128 bit)																															
JoinKey1 (32 bit)								JoinKey2 (32 bit)								JoinKey3 (32 bit)								JoinKey4 (32 bit)							
Num 1	Num 2	Num 3	Num 4	Num 5	Num 6	Num 7	Num 8	Num 1	Num 2	Num 3	Num 4	Num 5	Num 6	Num 7	Num 8	Num 1	Num 2	Num 3	Num 4	Num 5	Num 6	Num 7	Num 8	Num 1	Num 2	Num 3	Num 4	Num 5	Num 6	Num 7	Num 8
8	8	8	8	8	8	8	8	8	8	8	8	8	8	8	8	8	8	8	8	8	8	8	8	8	8	8	8	8	8	8	8

Fig. 15: Structure of the Join Key

12. Use or to select "JoinKey1...4".
13. Use to confirm your selection.
14. Use or to select "Num1...8".
15. Use to confirm your selection.
16. Use or to select the desired hexadecimal character (0 ... 9 + A ... F).
17. Use to confirm your selection.
18. Set the remaining characters Num2 ... Num8 and the Numbers JoinKey2 ... JoinKey4 according to steps 12. ... 13.
19. Use to select “Back”.



20. Use or to select "Join now".
21. Use to confirm your selection.
22. Use to call up the edit mode.
23. Use or to select "Join now" and use to confirm the action. To cancel the operation use or to select “-“ and use to confirm.

7.4.2 Configuration with the PC / laptop or handheld terminal

An EDD describes structure and type of device parameters but has only a limited influence on how this information is provided to the user.

The following is an example of how the EDD could be represented. Even the parameter names may be slightly different as tools typically use vendor specific libraries. Refer to the operating instructions for the handheld terminal.

The handheld terminal will allow you to set all the relevant information to let the SensyTemp TSP300-W join a WirelessHART network.

1. Ensure the TTX300-W EDD has been loaded into the HART handheld terminal.
2. Connect the HART handheld configurator to the instrument via the HART maintenance port.
3. Set the handheld terminal to polling (multidrop) mode and scan for devices. The SensyTemp TSP300-W has a default polling address of 0. Once connected you can edit the parameters and configuration data.
4. Configure the SensyTemp TSP300-W according the following steps (A) ... (J):

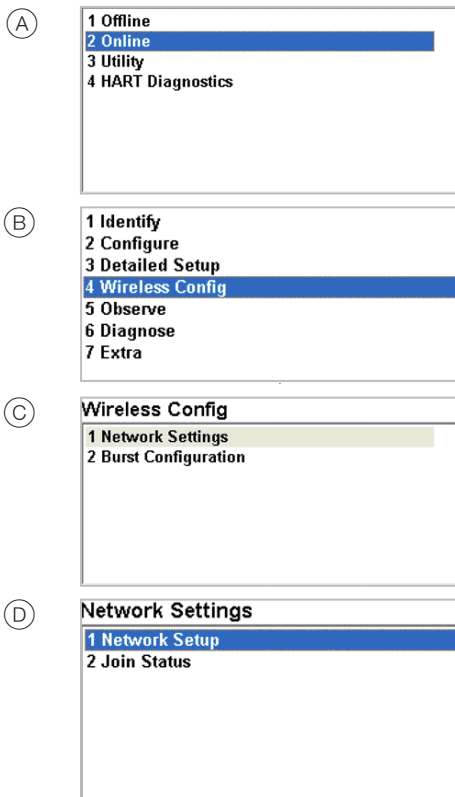

A11096

Fig. 16: Connect to the device and enter network setup (example)

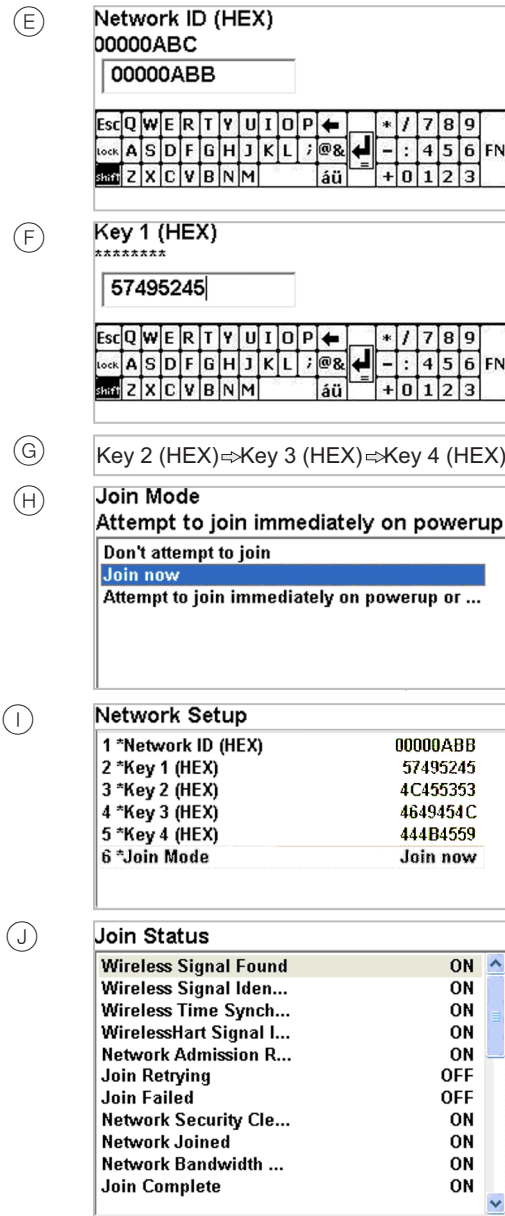

A11097

Fig. 17: Network setup (example)

i NOTE

Some handheld terminals or computer based tools require the Join Key (Key 1 ... Key 4) to be entered in decimal. The Join Key cannot be read back at the handheld terminal to ensure it remains secure.

7.4.3 Configuration with Device Type Manager (DTM)

The TTX300-W DTM gives access to all parameters and information relevant to communication and device commissioning.

Once the device is taken into the wireless network by the gateway the DTM can be used with the wired but also with the wireless interface, depending of the capabilities of FDT frame application and gateway.

Typically, the connection to the gateway is via Ethernet. This allows a remote access to the wireless HART network and the SensyTemp TSP300-W over intranet or Ethernet, depending on the network policies.

Components and tools provided or recommended by ABB do not have limitation regarding the communication interface.

7.4.4 Commissioning by Device Type Manager

Usually the network ID and join key needs to be set to allow a wireless device to enter an existing network. The join key and the network ID are also set in the gateway and must be the same as that entered in the SensyTemp TSP300-W.

The following description assumes the device needs a change of network parameters to join a network.

The DTM will have to be connected via a wired interface to the HART Maintenance Port of the SensyTemp TSP300-W. After searching for the device and getting into online mode, the dialog Network Settings should be opened:

Enter the following parameters:

Parameter	Value
Network ID	Enter the Network ID in decimal notation.
Join key	Enter the Join key in hexadecimal notation.
Join Mode	Choose „Join now“.

The Join Status on the bottom of the dialog gives status information about the process of network join. Whenever a wireless HART network is in the range of SensyTemp TSP300-W – even it does not match its own network parameters - the “Wireless signal found” flag is set.

This is a pre-condition to join a network. The SensyTemp TSP300-W now tries to join the network and to establish a connection to the wireless HART gateway. I successful join phase is indicated by the “Join complete” flag at the end. Depending of the network structure, size and performance of wireless HART gateway and other devices in the network it may take up to 60 minutes.

i Note

Some gateways need to switch on the “Active Advertising” in order to support devices to join the network.

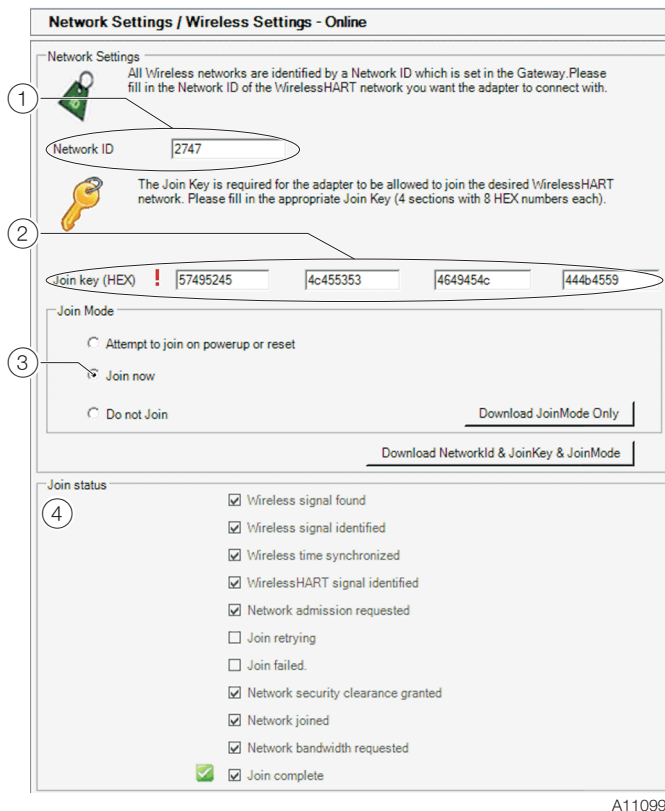

Fig. 18: DTM Network and Wireless Settings (example)

- ① Network ID (decimal) ② Join key (hexadecimal) ③ Join mode
④ Join status

7.4.5 Network Diagnostics by Device Type Manager

One of the strengths of wireless HART networks is the capability to automatically build a meshed structure. Therefore, the wireless devices try to connect to neighbors in order to get multiple paths for any telegram. The communication becomes robust by that. TTX300-W DTM supports you in checking the network transmission quality to and from the SensyTemp TSP300-W by powerful network diagnostics:

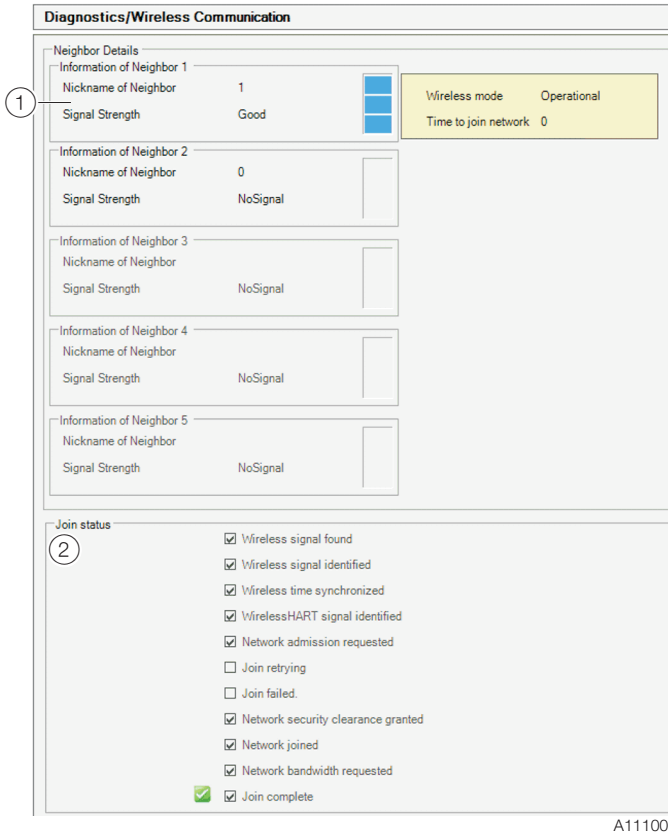

Fig. 19: DTM Network Diagnostics (example)

For a maximum of five neighbors, the signal strength of this specific link is shown. The signal strength is a computed value considering the signal level, retries required etc. In a proper and robust network, each wireless device should have at least three neighbors.

7.5 Operating instructions

If there is a chance that safe operation is no longer possible, take the device out of operation and secure it against unintended startup.

8 Operation

8.1 Activation of the LC display

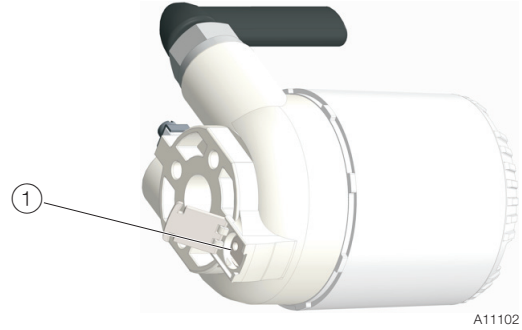

Fig. 20: Activation of LCD display
 ① Button to activate the LCD display

The optional LC display is switched off usually to save power and extend battery life time. It is activated (powered) for an adjustable time when pressing a button on the backside of the transmitter.

i NOTE

Permanent operation of the LC display will shorten the battery lifetime by about 50%. Therefore, the LC display shall be switched off when not in use / needed.

8.2 Hardware settings

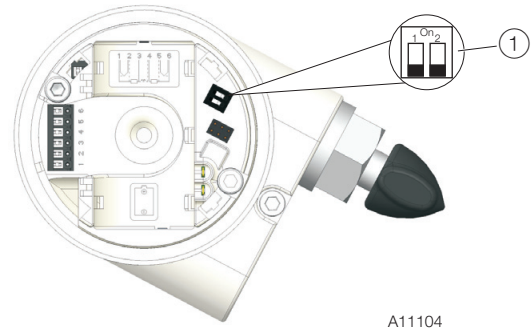

Fig. 21
 ① Dip Switches

Switch	Function
1 Local write protection	Off: Local write access disabled On: Local write access enabled
2 Standby mode (no radio communication)	Off: Normal operation On: Standby mode. The device does not have any wireless communication.

i NOTE

The standby mode disables the radio communication and put the electronics into deep sleep mode with a very low power consumption.

8.3 Menu navigation

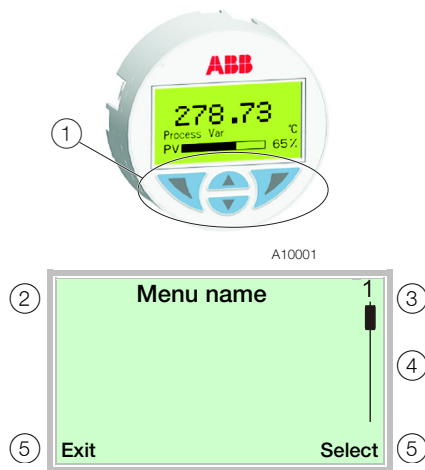

Fig. 22: LCD display (example)

- ① Operating buttons for menu navigation
- ② Menu name display ③ Menu number display
- ④ Marker for indicating the relative position within the menu
- ⑤ Display showing the current functions of the and operating buttons

You can use the or operating buttons to browse through the menu or select a number or character within a parameter value.

Different functions can be assigned to the and operating buttons. The function that is currently assigned to them is shown on the LCD display.

Control button functions

	Meaning
Exit	Exit menu
Back	Go back one submenu
Cancel	Cancel a parameter entry
Next	Select the next position for entering numerical and alphanumeric values

	Meaning
Select	Select submenu / parameter
Edit	Edit parameter
OK	Save parameter entered

8.4 Menu levels

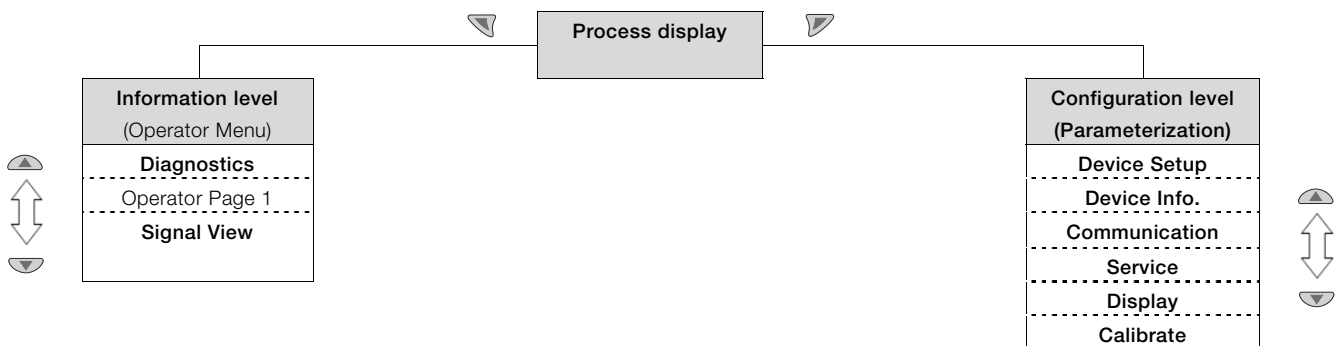

Process display

The process display shows the current process values. Two levels exist under the process display.

Information level (Operator Menu)

The information level contains the parameters and information that are relevant for the user. The device configuration cannot be changed on this level.

Configuration level (Parameterization)

The configuration level contains all the parameters required for device commissioning and configuration. The device configuration can be changed on this level.

For a detailed description of the individual parameters and menus on the configuration level refer to the chapter „Parameter descriptions“ on page 29.

8.4.1 Process display

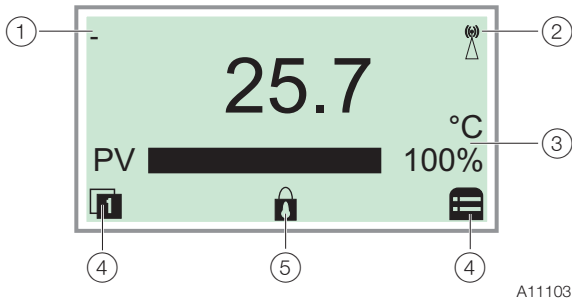



A11103





Fig. 23: Process display (example)

- ① Measuring point tagging (Device TAG)
- ② Status of the WirelessHART connection
- ③ Current process values
- ④ "Button function" symbol
- ⑤ "Parameterization protected" symbol

The process display appears on the LCD display when the device is switched on. It shows information about the device and current process values.

The way in which the current process values are shown can be adjusted on the configuration level.

The symbols at the bottom of the process display are used to indicate the functions of the operating buttons  and , in addition to other information.



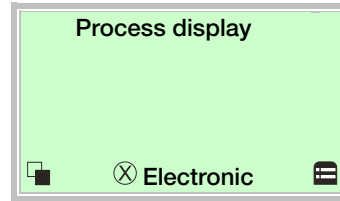

Symbol	Description
	Status of the WirelessHART connection <ul style="list-style-type: none"> – If the symbol flashes, the device is searching for a network – If the symbol is permanently visible, the device is connected to a network
	Call up information level.
	Call up configuration level.
	The device is protected against changes of the parameter settings.

Error messages on the LCD display

In the event of an error, a message consisting of a symbol and text (e.g., electronics) appears at the bottom of the process display. The text displayed provides information about the area in which the error has occurred.



The error messages are divided into four groups in accordance with the NAMUR classification scheme. The group assignment can only be changed using a DTM or EDD.

Symbol	Description
	Error / Failure
	Functional check
	Outside of specifications
	Maintenance required

The error messages are also divided into the following areas:

Area	Description
Electronics	Diagnostics for device hardware.
Sensor	Diagnostics for sensor elements and supply lines.
Installation / Configuration	Diagnostics for communication interface and parameterization / configuration.
Operating conditions	Diagnostics for ambient and process conditions.

i NOTE

For a detailed description of the errors and information on how to remedy them, refer to chapter „

Diagnosis / error messages“ on page 34.

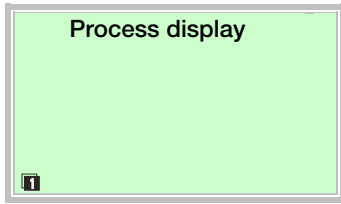

8.4.2 Switching to the information level (operator menu)

On the information level, the operator menu can be used to display diagnostic information and choose which operator pages to display.

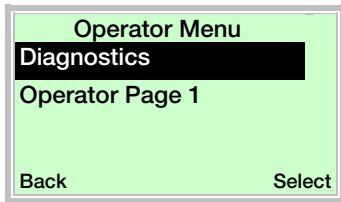

1. Use  to switch to the Operator Menu.





2. Use  /  to select a submenu.
3. Use  to confirm your selection.

Menu	Description
... / Operator Menu	
Diagnostics	Selects the " Diagnostics " submenu; see also Chapter „Calling up the error description" on page 34.
Operator Page 1	Selects the operator page to be displayed
Signal View	Selects the " Signal View " submenu, in which all dynamic readings are displayed

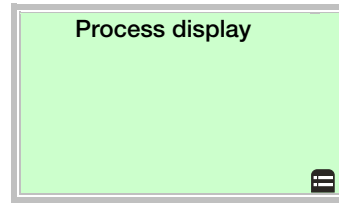

8.4.3 Switching to the configuration level (parameterization)

The device parameters can be displayed and changed on the configuration level.



1. Use  to switch to the configuration level.

The LCD display now indicates the first menu item on the configuration level.

2. Use  /  to select a menu.
3. Use  to confirm your selection.

8.4.4 Selecting and changing parameters

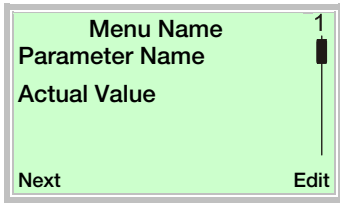

Entry from table

When an entry is made from a table, a value is selected from a list of parameter values.

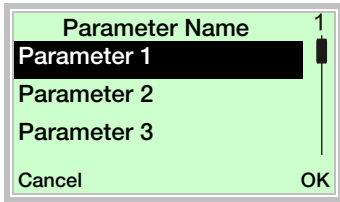

1. Select the parameters you want to set in the menu.
2. Use  to call up the list of available parameter values. The parameter value that is currently set is highlighted.



3. Use  /  to select the required value.
 4. Use  to confirm your selection.
- This concludes the procedure for selecting a parameter value.



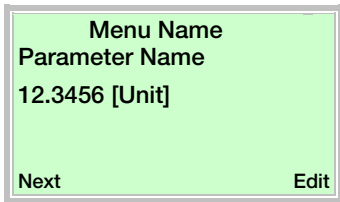

Numerical entry

When a numerical entry is made, a value is set by entering the individual decimal positions.

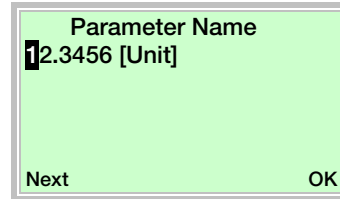

1. Select the parameters you want to set in the menu.
2. Use  to call up the parameter for editing. The position that is currently selected is highlighted.





3. Use  to select the decimal position to be changed.
4. Use  /  to set the required value.
5. Use  to select the next decimal position.
6. If necessary, select and set other decimal positions using the same procedure as described in steps 3 and 4.
7. Use  to confirm your settings.

This concludes the procedure for changing a parameter value.



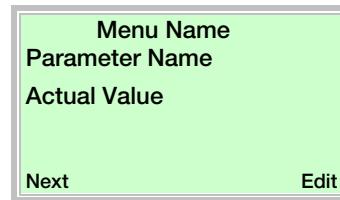

Alphanumeric entry

When an alphanumeric entry is made, a value is set by entering the individual decimal positions.

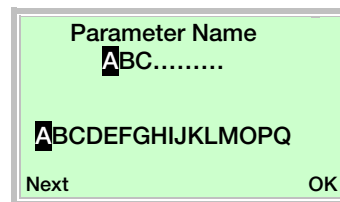

1. Select the parameter you want to set in the menu.
2. Use  to call up the parameter value for editing. The position that is currently selected is highlighted.



3. Use  to select the position to be changed.
4. Use  /  to select the required character.
5. Use  to select the next position.
6. If necessary, select and set other decimal positions using the same procedure as described in steps 3 and 4.
7. Use  to confirm your setting.

This concludes the procedure for changing a parameter value.

8.5 Overview of parameters on the configuration level

i NOTE

This overview of parameters shows all the menus and parameters available on the device. Depending on the version and configuration of the device, not all of the menus and parameters may be visible on it.

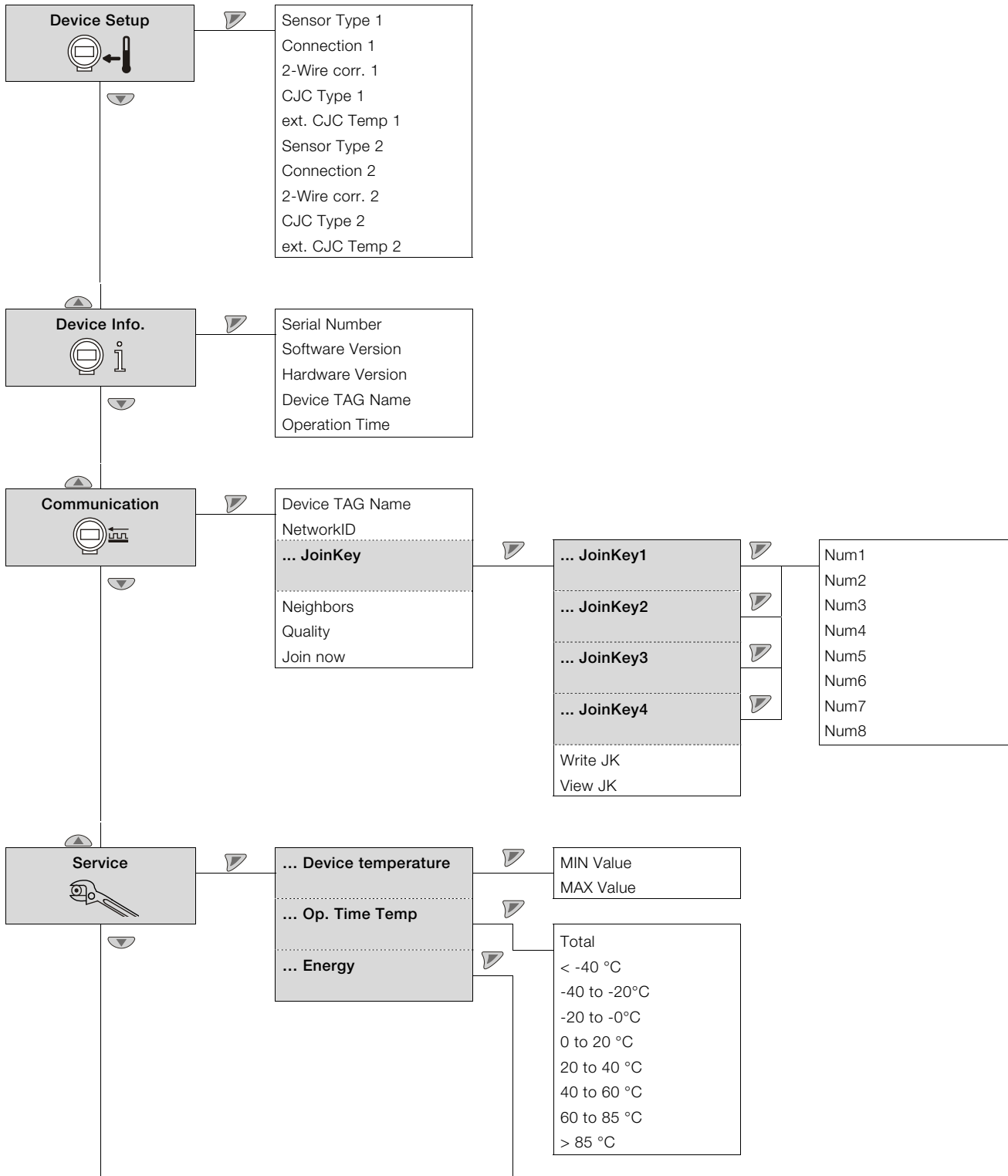

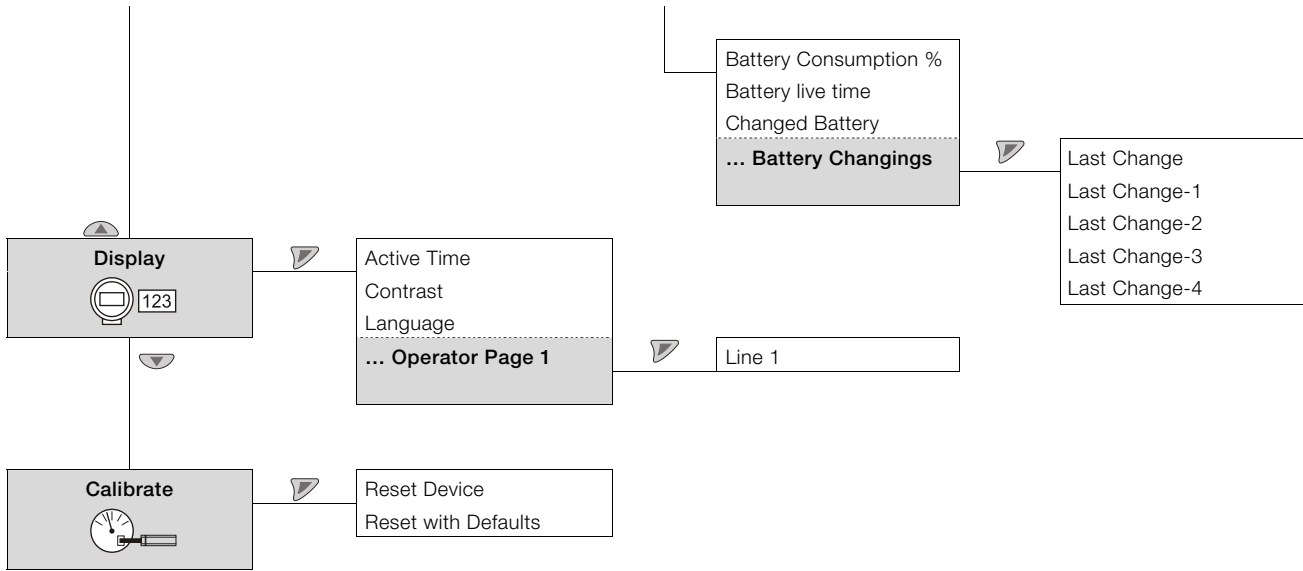

8.6 Parameter descriptions

8.6.1 Menu: Device Setup

Menu / Parameter	Value range	Description
... / Device Setup		
Sensor Type 1		Selects sensor type.
Sensor Type 2	Pt100 (IEC 751)	Pt100 resistance thermometer (IEC 751)
	Pt1000 (IEC 751)	Pt1000 resistance thermometer (IEC 751)
	TC type K (IEC 584)	Thermocouple type K (IEC 584)
	TC type B (IEC 584)	Thermocouple type B (IEC 584)
	TC type C (ASTME 988)	Thermocouple type C (IEC 584)
	TC type D (ASTME 988)	Thermocouple type D (ASTME 988)
	TC type E (IEC 584)	Thermocouple type E (IEC 584)
	TC type J (IEC 584)	Thermocouple type J (IEC 584)
	TC type N (IEC 584)	Thermocouple type N (IEC 584)
	TC type R (IEC 584)	Thermocouple type R (IEC 584)
	TC type S (IEC 584)	Thermocouple type S (IEC 584)
	TC type T (IEC 584)	Thermocouple type T (IEC 584)
	TC type L (DIN 43710)	Thermocouple type L (DIN 43710)
	TC type U (DIN 43710)	Thermocouple type U (DIN 43710)
	-125 ... 125 mV	Linear voltage measurement -125 ... 125 mV
	-125 ... 1,100 mV	Linear voltage measurement -125 ... 1,100 mV
	0 ... 500 Ω	Linear resistance measurement 0 ... 500 Ω
	0 ... 5,000 Ω	Linear resistance measurement 0 ... 5,000 Ω
	Pt10 (IEC 751)	Pt10 resistance thermometer (IEC 751)
	Pt50 (IEC 751)	Pt50 resistance thermometer (IEC 751)
	Pt200 (IEC 751)	Pt200 resistance thermometer (IEC 751)
	Pt500 (IEC 751)	Pt500 resistance thermometer (IEC 751)
	Pt10 (JIS 1604)	Pt10 resistance thermometer (JIS 1604)
	Pt50 (JIS 1604)	Pt50 resistance thermometer (JIS 1604)
	Pt100 (JIS 1604)	Pt100 resistance thermometer (JIS 1604)
	Pt200 (JIS 1604)	Pt200 resistance thermometer (JIS 1604)
	Pt10 (IMIL 24388)	Pt10 resistance thermometer (MIL 24388)
	Pt50 (IMIL 24388)	Pt50 resistance thermometer (MIL 24388)
	Pt100 (MIL 24388)	Pt100 resistance thermometer (MIL 24388)
	Pt200 (MIL24388)	Pt200 resistance thermometer (MIL 24388)
	Pt1000 (MIL24388)	Pt1000 resistance thermometer (MIL 24388)
	Ni50 (DIN43760)	Ni50 resistance thermometer (DIN 43716)
	Ni100 (DIN43760)	Ni100 resistance thermometer (DIN 43716)
	Ni120 (DIN43760)	Ni120 resistance thermometer (DIN 43716)
	Ni1000 (DIN43760)	Ni1000 resistance thermometer (DIN 43716)
	Cu10 a=4270	Cu10 resistance thermometer a = 4,270
	Cu100 a=4270	Cu100 resistance thermometer a = 4,270
	Fixpoint-Tabl. 1	Customer-specific characteristic curve 1
	Fixpoint-Tabl. 2	Customer-specific characteristic curve 2
	Fixpoint-Tabl. 3	Customer-specific characteristic curve 3
	Fixpoint-Tabl. 4	Customer-specific characteristic curve 4
	Fixpoint-Tabl. 5	Customer-specific characteristic curve 5
	Cal. Van Dusen 1	Callendar Van Dusen coefficient set 1
	Cal. Van Dusen 2	Callendar Van Dusen coefficient set 2
	Cal. Van Dusen 3	Callendar Van Dusen coefficient set 3
	Cal. Van Dusen 4	Callendar Van Dusen coefficient set 4
	Cal. Van Dusen 5	Callendar Van Dusen coefficient set 5
	off	Sensor channel deactivated (sensor 2 only)



Menu / Parameter	Value range	Description
... / Device Setup		
Connection 1	2-wire	Sensor connection type relevant for all Pt, Ni, Cu resistance thermometers
Connection 2	3-wire	
	4-wire	
2-Wire corr. 1	0 ... 100 Ω	
2-Wire corr. 2		
CJC Type 1	intern	Reference point configuration. — intern: Use of internal reference point for transmitter when using thermal compensating line. — extern: Use of external, fixed reference point for transmitter when using a constant thermostat temperature (can be set with external reference point). — not used: No reference point. — Sensor 1: Use of sensor 1 as reference point for sensor 2.
CJC Type 2	extern	
	not used	
	Sensor 1	
ext. CJC Temp 1	-50 ... 100 °C	Relevant for external reference point, specification of constant external reference point temperature.
ext. CJC Temp 2		

8.6.2 Menu: Device Info.





This menu is used only to display the device parameters.

Menu / Parameter	Value range	Description
... / Device Info.		
Device ID		Displays device ID
Serial Number		Displays serial number
Software Version		Displays software version
Hardware Version		Displays hardware version
Device TAG Name		Displays measuring point ID
Descriptor		Displays a user-defined text
Operation Time		Displays operating hours

8.6.3 Menu: Communication

Menu / Parameter	Value range	Description
... / Communication		
Device TAG Name	Alphanumeric, max. 16 characters	Enter the measuring point TAG of the device (shown in the upper left of the process display).
NetworkID	Decimal notation	Enter the WirelessHART network ID.
JoinKey		Select the " JoinKey " submenu.
Neighbors	–	Show the neighbors in the WirelessHART Network.
Quality	–	Show the WirelessHART network transmission quality.
Join now		Join network with the configured parameters.



... / Communication / JoinKey

JoinKey1		Select the " JoinKey1 " ... " JoinKey4 " submenu.																																																								
JoinKey2		The four numbers of the join key are again separated as 8 single hexadecimal characters 0 ... 9 + A ... F.																																																								
JoinKey3																																																										
JoinKey4																																																										
<table border="1" style="width: 100%; text-align: center;"> <thead> <tr> <th colspan="16">Join key (128 bit)</th> </tr> <tr> <th colspan="4">JoinKey1 (32 bit)</th> <th colspan="4">JoinKey2 (32 bit)</th> <th colspan="4">JoinKey3 (32 bit)</th> <th colspan="4">JoinKey4 (32 bit)</th> </tr> </thead> <tbody> <tr> <td>Num 1</td><td>Num 2</td><td>Num 3</td><td>Num 4</td> <td>Num 5</td><td>Num 6</td><td>Num 7</td><td>Num 8</td> <td>Num 1</td><td>Num 2</td><td>Num 3</td><td>Num 4</td> <td>Num 5</td><td>Num 6</td><td>Num 7</td><td>Num 8</td> <td>Num 1</td><td>Num 2</td><td>Num 3</td><td>Num 4</td> <td>Num 5</td><td>Num 6</td><td>Num 7</td><td>Num 8</td> </tr> </tbody> </table>			Join key (128 bit)																JoinKey1 (32 bit)				JoinKey2 (32 bit)				JoinKey3 (32 bit)				JoinKey4 (32 bit)				Num 1	Num 2	Num 3	Num 4	Num 5	Num 6	Num 7	Num 8	Num 1	Num 2	Num 3	Num 4	Num 5	Num 6	Num 7	Num 8	Num 1	Num 2	Num 3	Num 4	Num 5	Num 6	Num 7	Num 8
Join key (128 bit)																																																										
JoinKey1 (32 bit)				JoinKey2 (32 bit)				JoinKey3 (32 bit)				JoinKey4 (32 bit)																																														
Num 1	Num 2	Num 3	Num 4	Num 5	Num 6	Num 7	Num 8	Num 1	Num 2	Num 3	Num 4	Num 5	Num 6	Num 7	Num 8	Num 1	Num 2	Num 3	Num 4	Num 5	Num 6	Num 7	Num 8																																			
Write JK		Write JoinKey (128 bit) to the device.																																																								
View JK		View JoinKey (128 Bit) after editing.																																																								

... / Communication / JoinKey1 ... 4

Num1	hexadecimal characters 0 ... 9 + A ... F	Enter the hexadecimal characters for each JoinKey number.
Num2		
Num3		
Num4		
Num5		
Num6		
Num7		
Num8		

8.6.4 Menu: Service

Menu / Parameter	Value range	Description
... / Service		
Device temperature		Select the " Device temperature " submenu.
Op. Time Temp		Select the " Op. Time Temp " submenu.
Energy		Select the " Energy " submenu.

... / Service / Device temperature		
MIN Value		Highest / lowest detected internal temperature in °C that the transmitter was subjected to. See Chapter „Monitoring of operating values“ on page 34.
MAX Value		

... / Service / Op. Time Temp		
Total		Total hours since commissioning that the supply voltage has been switched on for the transmitter.
< -40 °C		The operating hours are categorized according to the measured internal temperature of the transmitter. See Chapter „Monitoring of operating values“ on page 34.
-40 to -20 °C		
-20 to 0 °C		
0 to 20 °C		
20 to 40 °C		
40 to 60 °C		
60 to 85 °C		
> 85 °C		

... / Service / Energy		
Battery Consumption %		Displays the battery consumption in percent.
Battery live time		Displays the remaining battery lifetime in years.
Changed Battery	Not Changed, Changed	Confirm Battery Change.
Battery Changings		Select the " Battery Changings " submenu.

... / Service / Energy / Battery Changings		
Battery Change		Indicates the running hours counter at the last (L) Battery change.
Battery Change-1		Indicates the running hours counter at the LL battery change.
Battery Change-2		Indicates the running hours counter at the LLL battery change.
Battery Change-3		Indicates the running hours counter at the LLLL battery change.
Battery Change-4		Indicates the running hours counter at LLLLL battery change.

8.6.5 Menu: Display

Menu / Parameter	Value range	Description
... / Display		
Language	German, English	Select the menu language.
Contrast	0 ... 100 %	Contrast setting for the LCD display.
Operator Page 1		Select the "Operator Page 1" submenu.
... / Display / Operator Page 1		
Line 1	Calculated value Sensor 1 Sensor 2 Device Temperature AO Block	Selects the value displayed.

8.6.6 Menu: Calibrate

Menu / Parameter	Value range	Description
... / Calibrate		
Reset Device		Device restarts without configuration changes.
Reset with Defaults		Device restarts with factory settings applied.

9 Diagnosis / error messages

9.1 Diagnostic information

9.1.1 Monitoring of operating values

The transmitter saves the highest and lowest values for the electronic unit temperature as well as readings from sensor 1 and sensor 2 in the non-volatile memory ("Drag Indicator"). See chapter „Menu: Service “ on page 32.

Value	Descriptions
Max. elec. temp.	Highest detected internal temperature in °C that the transmitter was subjected to. This value cannot be reset.
Min. elec. temp.	Lowest detected internal temperature in °C that the transmitter was subjected to. This value cannot be reset.
Max. reading for sensor 1 / 2	Highest reading at sensor 1 or 2. When changing the sensor type (e.g., Pt100 to thermocouple type K), the value is reset automatically.
Min. reading for sensor 1 / 2	Lowest reading at sensor 1 or 2. When changing the sensor type, the value is reset automatically.
Reset	The drag indicators for the sensor readings are all reset to the current reading in each case.

9.1.2 Operating hours statistics

Value	Descriptions
Operation Time	Total hours since commissioning that the supply voltage has been switched on for the transmitter
Operation Time (according to electronic unit temperature)	The operating hours are categorized according to the measured internal temperature of the transmitter. Due to rounding and frequently switching the device on and off, the total of the individual values may differ slightly from the value displayed by the counter for operating hours. Values in the fields on the far left and right indicate operation of the transmitter outside the specified range. In this event, acknowledged properties of the transmitter might be limited, in particular, with respect to accuracy and service life.

9.2 Calling up the error description

Additional details about the error that has occurred can be called up on the information level.

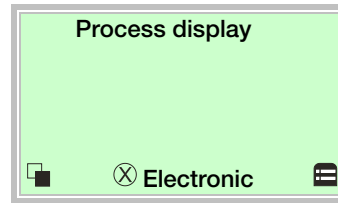

1. Use to switch to the information level.



- Use or to select the "Diagnostics" submenu.
- Use to confirm your selection.

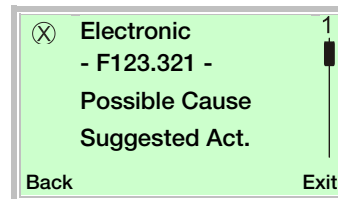

The first line shows the area in which the error has occurred. The second line shows the unique error number. The next lines show a brief description of the error and information on how to remedy it.



NOTE

For a detailed description of the errors and information on how to remedy them, please refer to Chapter „

Diagnosis / [error messages](#)“ on page 34.

9.3 Possible error messages

Area	Device status message (on the display)	Cause	Remedy
Sensor	Sensor drift	Out of specification	Sensor adjustment
Sensor	S1 line resistance too high	Maintenance required	Sensor 1: Remove corrosion at the connections or reduce line length
Sensor	S1 short circuit	Error	Sensor 1: Rectify short circuit or replace sensor 1
Sensor	S1 wire break	Error	Sensor 1: Rectify wire break or replace sensor 1
Sensor	S2 line resistance too high	Maintenance required	Sensor 2: Remove corrosion at the connections or reduce line length
Sensor	S2 short circuit	Error	Sensor 2: Rectify short circuit or replace sensor 2
Sensor	S2 wire break	Error	Sensor 2: Rectify wire break or replace sensor 2
Operating conditions	S1 measurement range overflow	Out of specification	Adapt S1 measurement range to suit measuring task
Operating conditions	S1 measurement range underflow	Out of specification	Adapt S1 measurement range to suit measuring task
Operating conditions	S2 measurement range overflow	Out of specification	Adapt S2 measurement range to suit measuring task
Operating conditions	S2 measurement range underflow	Out of specification	Adapt S2 measurement range to suit measuring task
Operating conditions	Device temperature out of spec.	Out of specification	Check environment; reposition measuring point if required
Electronics	Device error	Error	Replace device
Electronics	Device not calibrated	Out of specification	Calibrate device
Electronics	Device being simulated	Functional check	Terminate simulation
Electronics	Configuration error	Error	Validate configuration
Sensor	Sensor 1 + 2 redundancy failure	Error	Check sensor / sensor connection
Sensor	Sensor 1 redundancy: Short circuit	Maintenance required	Rectify short circuit at sensor 1 or replace sensor 1
Sensor	Sensor 1 redundancy: Wire break	Maintenance required	Rectify break at sensor 1 or replace sensor 1
Sensor	Sensor 2 redundancy, short circuit	Maintenance required	Rectify short circuit at sensor 2 or replace sensor 2
Sensor	Sensor 2 redundancy, wire break	Maintenance required	Rectify break at sensor 2 or replace sensor 2

i NOTE

If the remedial measures listed for the diagnostic information do not improve the status of the device, please consult ABB Service.

10 Maintenance

⚠ WARNING

Risk of explosion!

Faulty transmitters may not be placed into operation by the user.

Repairs must be performed from ABB service.

For transmitters that are used as intended under normal operation, no maintenance is required.
No on-site repair or replacement of electronic parts is planned.

10.1 Cleaning

When cleaning the exterior of meters, make sure that the cleaning agent used does not corrode the housing surface and the gaskets.

10.2 Replacing the battery

⚠ CAUTION

Corrosion, fire and explosion hazard if lithium batteries are not properly handled.

Lithium batteries contain acids and may explode if they are exposed to extreme heat, become mechanically damaged or are electrically overloaded.

- Never charge or short-circuit lithium batteries
 - Never expose lithium batteries to temperatures > 100 °C (> 212 °F) or to fire
 - Never use damaged lithium batteries
-

For detailed information about handling lithium batteries, see chapter „Handling of lithium ion batteries“ on page 5.

⚠ WARNING

Risk of explosion!

Risk of explosion from the use of incorrect or damaged batteries, or from improper replacement.

- Only genuine batteries from ABB with the order number 3KXT000029U0000 may be used for replacement
 - Before inserting the new battery, check it for leaks or mechanical damage
 - Take appropriate measures to prevent electrostatic charges on the plastic sleeve of the battery
-

i NOTE

The battery can be replaced in potentially explosive atmospheres because all circuits in the device are intrinsically safe.

Replacing the battery:

1. Unscrew the housing cover.
2. Carefully pull the LCD indicator to release it from its bracket.
3. Remove the battery from the bracket.
4. Insert the new battery into the bracket while observing the polarity (+/- symbols on the battery and the bracket).
5. Select the "Service / Energy" menu on the LCD indicator. Select the parameter "Change Battery". Select the entry "Changed" and confirm with "OK". The LCD indicator then shows "not changed".
6. Carefully insert the LCD indicator in the required position.
7. Screw the housing cover back on.

i NOTE

If the O-ring gasket is seated incorrectly or is damaged, this may have an adverse effect on the IP rating.

Check the O-ring gasket for damage and replace it if necessary before closing the housing cover.

Check that the O-ring gasket is properly seated when closing the housing cover.

11 Repair

Repair and maintenance activities may only be performed by authorized customer service personnel. When replacing or repairing individual components, use original spare parts.

11.1 Changing the measuring inset

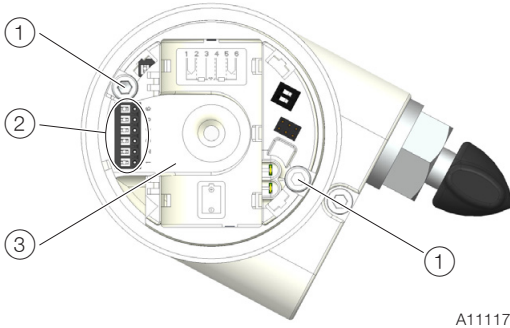

Fig. 24: Replace the measuring inset
① fastening screws ② connection board ③ transmitter block

To replace the measuring inset:

1. Disconnect the measuring inset from the connection board (2).
2. Disconnect the fastening screws (1) of the transmitter block (3).
3. Remove the transmitter block (3) of the housing carefully.

i NOTE

Take care of the antenna cable connection. Disconnect the antenna cable after you have removed carefully the transmitter block.

4. Disconnect the antenna cable.
5. Change the measuring inset.
6. Connect the antenna cable.

i NOTE

Do not squeeze nor twist the antenna cable. The antenna cable must be placed with one loop below the measuring inset.

7. If the new measuring inset is installed, then put the transmitter block (3) into the housing and fasten it with the screws (1).
8. Connect the measuring inset to the connection board (2).

11.2 Returning devices

⚠ CAUTION

Corrosion, fire and explosion hazard if lithium batteries are not properly handled.

Lithium batteries contain acids and may explode if they are exposed to extreme heat, become mechanically damaged or are electrically overloaded.

- Never charge or short-circuit lithium batteries
 - Never expose lithium batteries to temperatures > 100 °C (> 212 °F) or to fire
 - Never use damaged lithium batteries
-

For detailed information about handling lithium batteries, see chapter „Handling of lithium ion batteries“ on page 5.

Use the original packaging or a secure transport container of an appropriate type if you need to return the device for repair or recalibration purposes. Fill out the return form (see the Appendix) and include this with the device.

According to the EU Directive governing hazardous materials, the owner of hazardous waste is responsible for its disposal or must observe the following regulations for shipping purposes: All devices delivered to ABB must be free from any hazardous materials (acids, alkalis, solvents, etc.).

Please contact Customer Center Service acc. to page 2 for nearest service location.

12 Recycling and disposal

12.1 Disposal

CAUTION

Corrosion, fire and explosion hazard if lithium batteries are not properly handled.

Lithium batteries contain acids and may explode if they are exposed to extreme heat, become mechanically damaged or are electrically overloaded.

- Never charge or short-circuit lithium batteries
- Never expose lithium batteries to temperatures > 100 °C (> 212 °F) or to fire
- Never use damaged lithium batteries

For detailed information about handling lithium batteries, see chapter 1.5 "Handling of lithium ion batteries" on page 5.

NOTE



Products that are marked with this symbol may not be disposed of through municipal garbage collection points.

This product and its packaging are manufactured from materials that can be recycled by specialist recycling companies.

13 Spare parts, consumables and accessories

Repair and maintenance activities may only be performed by authorized customer service personnel.

When replacing or repairing individual components, use original spare parts.

14 Specifications

NOTE

The detailed device data sheet is available in the download area at www.abb.com/temperature.

Bear the following points in mind when disposing of them:

- This product is not subject to WEEE Directive 2002/96/EC or relevant national laws (e.g. ElektroG in Germany).
- The product must be surrendered to a specialist recycling company. Do not use municipal garbage collection points. According to WEEE Directive 2002/96/EC, only products used in private applications may be disposed of at municipal garbage collection points.
- If it is not possible to dispose of old equipment properly, ABB Service can take receipt of and dispose of returns for a fee.

12.2 Information on ROHS Directive 2011/65/EC

The products provided by ABB Automation Products GmbH do not fall within the current scope of regulations on hazardous substances with restricted uses or the directive on waste electrical and electronic equipment according to ElektroG.

If the necessary components are available on the market at the right time, in the future these substances will no longer be used in new product development.

Trademarks

® WirelessHART is a registered trademark of the HART Communication Foundation

15 Appendix

15.1 Return form

Statement on the contamination of devices and components

Repair and / or maintenance work will only be performed on devices and components if a statement form has been completed and submitted.

Otherwise, the device / component returned may be rejected. This statement form may only be completed and signed by authorized specialist personnel employed by the operator.

Customer details:

Company: _____
Address: _____
Contact person: _____ Telephone: _____
Fax: _____ E-Mail: _____

Device details:

Typ: _____ Serial no.: _____
Reason for the return/description of the defect: _____

Was this device used in conjunction with substances which pose a threat or risk to health?

Yes No

If yes, which type of contamination (please place an X next to the applicable items)?

Biological	<input type="checkbox"/>	Corrosive / irritating	<input type="checkbox"/>	Combustible (highly / extremely combustible)	<input type="checkbox"/>
Toxic	<input type="checkbox"/>	Explosiv	<input type="checkbox"/>	Other toxic substances	<input type="checkbox"/>
Radioactive	<input type="checkbox"/>				

Which substances have come into contact with the device?

1. _____
2. _____
3. _____

We hereby state that the devices / components shipped have been cleaned and are free from any dangerous or poisonous substances.

Town/city, date

Signature and company stamp



EG-Konformitätserklärung EC Declaration of Conformity

ABB Automation Products GmbH
Schillerstrasse 72
32425 Minden
Germany

declares that the product
erklärt, dass das Produkt

Device: Temperature Sensor WirelessHART
Gerät: Temperatur Sensor WirelessHART

Type designation: TSP311-W..., TSP321-W...
Typbezeichnung: TSP331-W..., TSP341-W...

is in conformity with the provisions of the following European Community Directives:
mit den Vorschriften folgender Europäischer Richtlinien übereinstimmt:

2004/108/EC	Electromagnetic Compatibility EMC <i>Elektromagnetische Verträglichkeit EMV</i>
94/9/EC	Equipment and protective systems intended for use in potentially explosive atmospheres ATEX <i>Geräte und Schutzsysteme zur bestimmungsgemäßen Verwendung in explosionsgefährdeten Bereichen ATEX</i>
1999/5/EC	Radio equipment and telecommunications terminal equipment R&TTE <i>Funkanlagen und Telekommunikationsendeinrichtungen FTEG</i>

Annexes are part of this declaration.

Die Anhänge sind Bestandteil dieser Erklärung.

This declaration certifies the conformity to the specified directives but contains no assurance of properties.

Diese Erklärung bescheinigt die Übereinstimmung mit den genannten Richtlinien, beinhaltet jedoch keine Zusicherung von Eigenschaften im rechtlichen Sinne.

The safety documentation of the product shall be considered in detail.

Die Sicherheitshinweise der mitgelieferten Produktdokumentation sind zu beachten.

Minden, 19.09.2014

i.V. Dr. Wolfgang Scholz
Head of Quality Management
Leiter Qualitätsmanagement

i.V. Tilo Merlin
Head of R&D
Leiter Entwicklung

ABB Automation Products GmbH

3KXT161300D0001 Rev.A

1 / 3

Annex 2004/108/EC
Anlage 2004/108/EG

Electromagnetic Compatibility EMC
Elektromagnetische Verträglichkeit EMV

Type designation:
Typbezeichnung: TSP311-W..., TSP321-W...
TSP331-W..., TSP341-W...

Standards:
Normen: EN61326-1 : 2013

Electromagnetic susceptibility:
Störfestigkeit: Industrial Environment
Industrielle Umgebung

Electromagnetic disturbance:
Elektromagnetische Störaussendung: Class B
Klasse B

Annex 1999/5/EC Radio equipment and telecommunications terminal equipment R&TTE
Anlage 1999/5/EG Funkanlagen und Telekommunikationsendeinrichtungen FTEG

Type designation:
Typbezeichnung: TSP311-W..., TSP321-W...
TSP331-W..., TSP341-W...

Standards:
Normen: EN301489-1 : V1.9.2 Cl.B
EN301489-17 : V2.2.1
EN300328 : V1.8.1 2004
EN62311 : 2008
EN60950-1: 2007

ABB Automation Products GmbH

3KXT161300D0001 Rev.A

2 / 3

Annex 94/9/EC **Equipment and protective systems intended for use in potentially explosive atmospheres ATEX**
Anlage 94/9/EG **Geräte und Schutzsysteme zur bestimmungsgemäßen Verwendung in explosionsgefährdeten Bereichen ATEX**

Type designation: TSP311-WA6..., TSP321-WA6...
Typbezeichnung: TSP331-WA6..., TSP341-WA6...

EC-Type Examination Certificate: PTB 14 ATEX 2010 X
EG-Baumusterprüfbescheinigung:

Marking: II 1G Ex ia IIC T4 Ga
Kennzeichnung:

Standards: EN60079-0 : 2012
Normen: EN60079-11 : 2012

Notified Body for Certificate: Physikalisch Technische Bundesanstalt (0102)
Benannte Stelle der Bescheinigung: 38116 Braunschweig, Germany

Notified Body Quality Assurance: TÜV NORD CERT GmbH (0044)
Benannte Stelle Qualitätssicherung 60516 Hannover, Germany
Produktion:

ABB Automation Products GmbH

3KXT161300D0001 Rev.A

3 / 3

Notes

Contact us

ABB Limited

Process Automation

Salterbeck Trading Estate
Workington, Cumbria
CA14 5DS UK

Tel: +44 (0)1946 830 611

Fax: +44 (0)1946 832 661

ABB Inc.

Process Automation

125 E. County Line Road
Warminster PA 18974
USA

Tel: +1 215 674 6000

Fax: +1 215 674 7183

ABB Automation Products GmbH

Process Automation

Schillerstr. 72
32425 Minden
Germany

Tel: +49 571 830-0

Fax: +49 571 830-1806

www.abb.com/temperature

Note

We reserve the right to make technical changes or modify the contents of this document without prior notice. With regard to purchase orders, the agreed particulars shall prevail. ABB does not accept any responsibility whatsoever for potential errors or possible lack of information in this document.

We reserve all rights in this document and in the subject matter and illustrations contained therein. Any reproduction, disclosure to third parties or utilization of its contents - in whole or in parts - is forbidden without prior written consent of ABB.

Copyright© 2015 ABB

All rights reserved

3KXT161300R4201

Translation of the original instruction

O1/TSP300-W-EN Rev. A.01.2015