

for air, compact design



Thermal Mass Flowmeter Sensyflow FMT200-ECO2

Operating Instruction

42/14-41-EN

06.2012

Rev. E

Translation of the original instruction

Manufacturer:

**ABB Automation Products GmbH
Process Automation**

Dransfelder Straße 2

D-37079 Göttingen

Germany

Tel.: +49 551 905-534

Fax: +49 551 905-555

Customer service center

Phone: +49 180 5 222 580

Fax: +49 621 381 931-29031

automation.service@de.abb.com

© Copyright 2012 by ABB Automation Products GmbH
Subject to changes without notice

This document is protected by copyright. It assists the user in safe and efficient operation of the device. The contents of this document, whether whole or in part, may not be copied or reproduced without prior approval by the copyright holder.

1	Safety	5
1.1	General information and notes for the reader	5
1.2	Intended use.....	5
1.3	Target groups and qualifications	5
1.4	Warranty provisions.....	5
1.5	Plates and symbols	6
1.5.1	Safety- / warning symbols, note symbols.....	6
1.6	Name plates	7
1.7	Safety instructions for electrical installation	8
1.8	Returning devices.....	8
1.9	Integrated management system.....	9
1.10	Disposal.....	9
1.10.1	Information on WEEE Directive 2002/96/EC (Waste Electrical and Electronic Equipment).....	9
1.10.2	RoHS Directive 2002/95/EC	9
2	Use in potentially explosive atmospheres	10
3	Design and function	10
3.1	LED status messages and error signals	10
4	Electrical connections	11
4.1	Cable assignments.....	11
4.2	Circuiting the signal outputs	11
4.2.1	Analog output	11
4.2.2	Digital output	11
4.2.3	Compatibility to Sensyflow eco1	11
5	Commissioning	12
5.1	Checking the preconditions	12
5.2	Selecting the installation site	12
5.3	Installing the process adapter into the measuring pipe.....	12
6	Parameterization	13
6.1	Overview parameterization program Sensyflow FMT200-ECO2	13
6.2	Changing the configuration	13
6.3	Installing the configuration program	14
6.4	Language selection	14
6.5	Starting the configuration program.....	15
6.6	Tab – actual settings.....	16
6.6.1	Device identification	16
6.6.2	Status bar.....	16
6.6.3	Standard specification.....	17
6.6.4	Digital output	17
6.6.5	Analog output	18
6.6.6	Measured value.....	18
6.6.7	The configuration menu	19
6.7	Tab – analog output.....	21
6.8	Tab – digital output	22
6.8.1	Frequency standard	22
6.8.2	Frequency variable.....	23
6.8.3	Impulse output.....	23
6.8.4	Switch output.....	24

Contents

6.8.5	No output.....	24
7	Maintenance / Service.....	25
8	Specifications	26
9	Dimensions	27
9.1	Flowmeter sensor FMT200-ECO2	27
9.2	Accessories	28
10	Configuration box (optional).....	30
11	Appendix	31
11.1	Decommissioning and packaging	31
11.2	Approvals and certifications	31

1 Safety

1.1 General information and notes for the reader

You must read these instructions carefully prior to installing and commissioning the device.

These instructions are an important part of the product and must be kept for future reference.

These instructions are intended as an overview and do not contain detailed information on all designs for this product or every possible aspect of installation, operation and maintenance.

For additional information or if specific problems occur that are not discussed in these instructions, contact the manufacturer.

The content of these instructions is neither part of any previous or existing agreement, promise or legal relationship nor is it intended to change the same.

This product is built based on state-of-the-art technology and is operationally safe. It has been tested and left the factory in perfect working order from a safety perspective. The information in the manual must be observed and followed in order to maintain this state throughout the period of operation.

Modifications and repairs to the product may only be performed if expressly permitted by these instructions.

Only by observing all of the safety instructions and all safety/warning symbols in these instructions can optimum protection of both personnel and the environment, as well as safe and fault-free operation of the device, be ensured.

Information and symbols directly on the product must be observed. They may not be removed and must be fully legible at all times.

1.2 Intended use

Mass flow measurement of gases and gas mixtures in closed pipelines.

The device is designed for use exclusively within the values stated on the name plate and in the technical specifications (see the section titled "Specifications").

1.3 Target groups and qualifications

Installation, commissioning, and maintenance of the product may only be performed by trained specialist personnel who have been authorized by the plant operator to do so. The specialist personnel must have read and understood the manual and comply with its instructions.

Prior to using corrosive and abrasive materials for measurement purposes, the operator must check the level of resistance of all parts coming into contact with the materials to be measured. ABB Automation Products GmbH will gladly support you in selecting the materials, but cannot accept any liability in doing so.

The operators must strictly observe the applicable national regulations with regards to installation, function tests, repairs, and maintenance of electrical products.

1.4 Warranty provisions

Using the device in a manner that does not fall within the scope of its intended use, disregarding this instruction, using underqualified personnel, or making unauthorized alterations releases the manufacturer from liability for any resulting damage. This renders the manufacturer's warranty null and void.

1.5 Plates and symbols

1.5.1 Safety- / warning symbols, note symbols



DANGER – <Serious damage to health / risk to life>

This symbol in conjunction with the signal word "Danger" indicates an imminent danger. Failure to observe this safety information will result in death or severe injury.



DANGER – <Serious damage to health / risk to life>

This symbol in conjunction with the signal word "Danger" indicates an imminent electrical hazard. Failure to observe this safety information will result in death or severe injury.



WARNING – <Bodily injury>

This symbol in conjunction with the signal word "Warning" indicates a possibly dangerous situation. Failure to observe this safety information may result in death or severe injury.



WARNING – <Bodily injury>

This symbol in conjunction with the signal word "Warning" indicates a potential electrical hazard. Failure to observe this safety information may result in death or severe injury.



CAUTION – <Minor injury>

This symbol in conjunction with the signal word "Caution" indicates a possibly dangerous situation. Failure to observe this safety information may result in minor or moderate injury. This may also be used for property damage warnings.



NOTICE – <Property damage>!

The symbol indicates a potentially damaging situation.

Failure to observe this safety information may result in damage to or destruction of the product and/or other system components.



IMPORTANT (NOTE)

This symbol indicates operator tips, particularly useful information, or important information about the product or its further uses. It does not indicate a dangerous or damaging situation.

1.6 Name plates

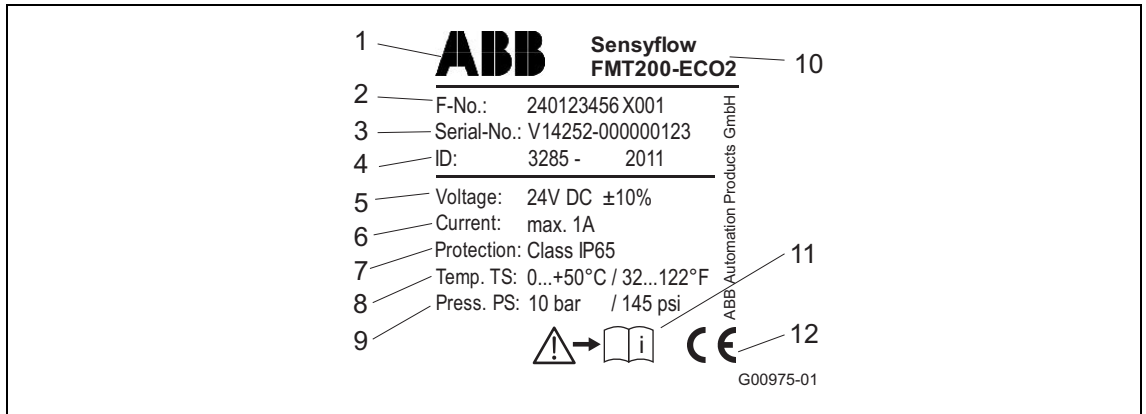

Fig. 1: Standard

- | | |
|---|---|
| 1 Manufacturer | 7 Protection class |
| 2 Serial number | 8 Operating temperature range |
| 3 Serial number | 9 Max. permissible pressure of medium for measurement |
| 4 ID number (internal calibration number) | 10 Type designation |
| 5 Power supply | 11 Refer to product documentation |
| 6 Maximum power | 12 CE mark (EC conformity) |

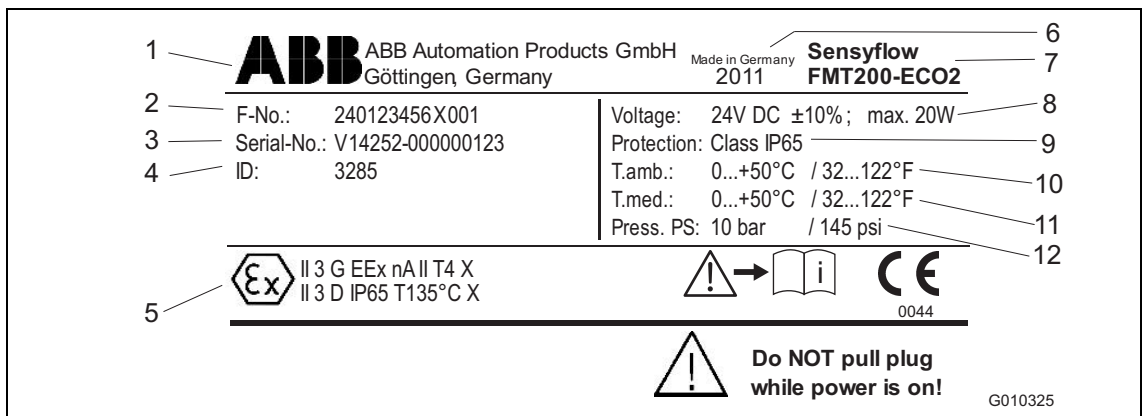

Fig. 2: With explosion protection

- | | |
|---|------------------------------------|
| 1 Manufacturer | 7 Type designation |
| 2 Serial number | 8 Power supply |
| 3 Serial number | 9 Protection class |
| 4 ID number (internal calibration number) | 10 Permissible ambient temperature |
| 5 Explosion protection labeling, e.g., ATEX | 11 Measured medium temperature |
| 6 Year of manufacture, country of manufacture | 12 Max. operating pressure |

1.7 Safety instructions for electrical installation

The electrical connection may only be made by authorized specialist personnel according to the electrical plans.

The electrical connection information in the manual must be observed; otherwise, the electrical protection type may be adversely affected.

Ground the measurement system according to requirements.

1.8 Returning devices

Use the original packaging or a secure transport container of an appropriate type if you need to return the device for repair or recalibration purposes. Fill out the return form (see the Appendix) and include this with the device.

The EU Directive governing hazardous materials dictates that the owners of any hazardous waste are also responsible for disposing of it.

All devices delivered to the manufacturer must be free from any hazardous materials (acids, alkalis, solvents, etc.).

Pipe components and flowmeter sensors contain hollow spaces. If they have been used in conjunction with hazardous materials, they must therefore be rinsed out in order to neutralize any such substances.

The owner will be charged for any costs incurred as a result of the device not having been adequately cleaned or of any failure to dispose of hazardous materials. The manufacturer reserves the right to return a contaminated device.

Please contact Customer Center Service acc. to page 2 for nearest service location.

1.9 Integrated management system

ABB Automation Products GmbH operates an integrated management system, consisting of:

- Quality management system to ISO 9001:2008
- Environmental management system to ISO 14001:2004
- Occupational health and safety management system to BS OHSAS 18001:2007 and
- Data and information protection management system

Environmental awareness is an important part of our company policy.

Our products and solutions are intended to have a minimal impact on the environment and on people during manufacturing, storage, transport, use, and disposal.

This includes the environmentally-friendly use of natural resources. We conduct an open dialog with the public through our publications.

1.10 Disposal

This product is manufactured from materials that can be reused by specialist recycling companies.

1.10.1 Information on WEEE Directive 2002/96/EC (Waste Electrical and Electronic Equipment)

This product is not subject to WEEE Directive 2002/96/EC or relevant national laws (e.g., ElektroG in Germany).

The product must be disposed of at a specialist recycling facility. Do not use municipal garbage collection points. According to the WEEE Directive 2002/96/EC, only products used in private applications may be disposed of at municipal garbage facilities. Proper disposal prevents negative effects on people and the environment, and supports the reuse of valuable raw materials.

If it is not possible to dispose of old equipment properly, ABB Service can accept and dispose of returns for a fee.

1.10.2 RoHS Directive 2002/95/EC

With the Electrical and Electronic Equipment Act (ElektroG) in Germany, the European Directives 2002/96/EC (WEEE) and 2002/95/EC (RoHS) are translated into national law. ElektroG defines the products that are subject to regulated collection and disposal or reuse in the event of disposal or at the end of their service life. ElektroG also prohibits the marketing of electrical and electronic equipment that contains certain amounts of lead, cadmium, mercury, hexavalent chromium, polybrominated biphenyls (PBB), and polybrominated diphenyl ethers (PBDE) (also known as hazardous substances with restricted uses).

The products provided by ABB Automation Products GmbH do not fall within the current scope of the directive on waste from electrical and electronic equipment according to ElektroG. If the necessary components are available on the market at the right time, in the future these substances will no longer be used in new product development.

2 Use in potentially explosive atmospheres

The device is available in a Zone 2 / Zone 22 certified version. Each of these units is shipped together with a EC declaration of conformity (ATEX) . For the operation of Zone 2 / Zone 22 certified devices only the values written down in this declaration of conformity (ATEX) are relevant. (see appendix).



WARNING - General risks!

Operating the device in Zone 1 / 21 or Zone 0 / 20 is not permitted.

3 Design and function



Fig. 3: Flowmeter sensor FMT200-ECO2

- 1 Process adapter connection
- 2 Current device status display (LED)
- 3 Connection socket

3.1 LED status messages and error signals

LED	Meaning
Green	Unit is OK and ready for operation
Green flashing	Unit is OK but out of measuring range
Red	Unit is out of order (repair required)
Red flashing	Initialization sequence running (approx. 30 s after start-up or parameter modification)
Red flashing 90 : 10 (ON : OFF)	Supply voltage too low (please check)
Red flashing 10 : 20 (ON : OFF)	EEPROM erased (repair required)

4 Electrical connections

Please use the supplied cable for the electrical connection of the flowmeter sensor. On the measuring unit, a connector is used for the coupling.

Use a 24 V DC power supply with isolation according to EN 61010 and IEC 950 with a maximum output of < 150 W only.

4.1 Cable assignments

Color of cores	Connector pin number	Signal
White	#1	Analog output +
Brown	#2	RS 232 / TxD
Green	#3	Pulse / frequency output
Yellow	#4	Power supply 24 V DC
Grey	#5	Power supply 0 V
Pink	#6	RS 232 / RxD
Blue	#7	GND / analog
Red	#8	GND / frequency + pulse + RS 232
Shielding	-	Functional earthing

4.2 Circuiting the signal outputs

4.2.1 Analog output

Upon selection, the analog output of the current output supplies an active signal of 0 (4) ... 20 mA, i. e. the Sensyflow FMT200-ECO2 device supplies the current independently.

For this reason, do not use a 2-wire power supply unit or an active input of a PLC, but rather a passive signal receiver.

4.2.2 Digital output

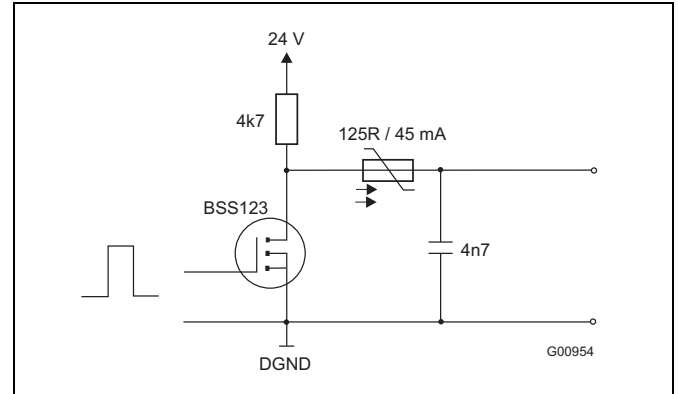

Fig. 4: Digital output

The digital output offers a 24 V = HIGH signal or a 0 V = LOW Signal. The digital output can be used as active or passive output.

Active digital output wiring

The output current in the HIGH-mode must be limited to 1 mA when the active digital output is used (passive signal receiver). This is to ensure an output voltage $U_a > 15 V$.

Passive digital output wiring

Using the passive output (active signal receiver), the output current in the LOW-mode must be limited to -20 mA. This is to ensure an output voltage $U_a < 2.5 V$.

4.2.3 Compatibility to Sensyflow eco1

Sensyflow eco1 und Sensyflow FMT200-ECO2 are compatible. Using the appropriate electrical adapter, FMT200-ECO2 can be connected to existing plants.

As "interface" and "digital output" functionality is not available with Sensyflow eco1, there is no wiring within the adapter for these functions.

5 Commissioning

5.1 Checking the preconditions

Accompanying every measuring system is a calibration certificate, containing all the important information (e.g. serial number, calibrated measuring range, order number, adjusted outputs at time of delivery). Please ascertain if this data corresponds to the requirements of the measuring point in question.

5.2 Selecting the installation site

- For ambient temperatures see chapter "Technical Data".
- The mounting position is arbitrary.
- To prevent negative effects on measurement accuracy, sufficient straight upstream length is required when small flange connectors ISO-KF flange DN 25, Transair, G 3/4" and G 1" are used. These entry lengths ensure elimination of flow profile irregularities before they reach the measuring point at the sensor.
- Use straight, smooth pipes with lengths of approx. 10 xD for the steadying lengths on the input side. If using the G 1/2" and G 3/8" adapters, no extra steadying lengths will be required, as flow stabilizing components have been installed on the inflow sides of the adapters. The flow straightener causes an increased pressure drop.
- Components affecting flow, such as valves or shut-off fittings should be possibly installed behind the measuring point.

5.3 Installing the process adapter into the measuring pipe



IMPORTANT (NOTE)

The variable process adapters are attached to the pipe with a fine internal threading. This connection can be carefully unscrewed, using a spanner SW 30. Before refitting, clean and lightly grease the process adapter threading. Make sure the O-ring is mounted properly.

6 Parameterization

6.1 Overview parameterization program Sensyflow FMT200-ECO2

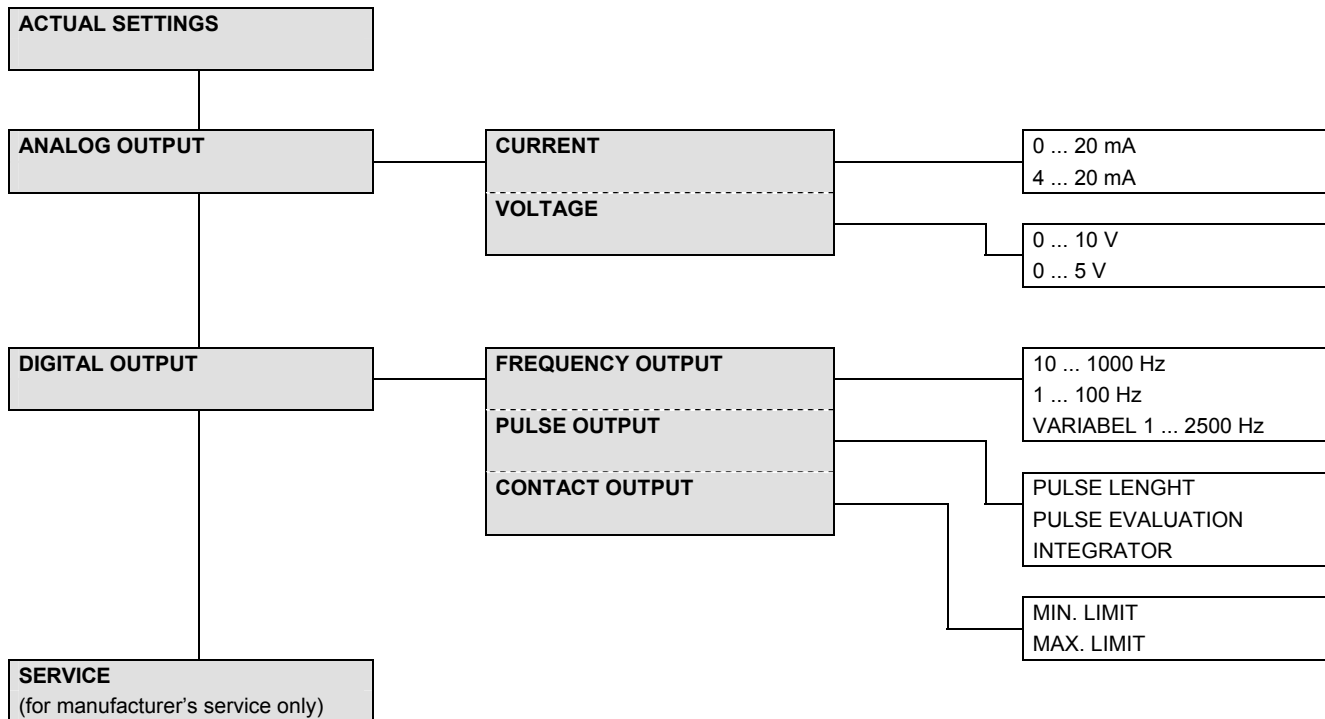

6.2 Changing the configuration

A standard PC can be used to change the device configuration (i.e., settings) to other measuring ranges, outputs, and parameters. The device also features an RS 232 standard interface.

A configuration box (order number 7962818) facilitates the simultaneous connection of a PC, power supply, and Sensyflow FMT200-ECO2.

System requirements

The configuration program has been designed for use with Microsoft Windows XP or higher. A help function contains instructions for the program.

6.3 Installing the configuration program

1. Start Windows.
2. Insert CD-ROM.
3. Launch SETUP.EXE.

The installation program creates a directory containing the required files. The directory can be modified.

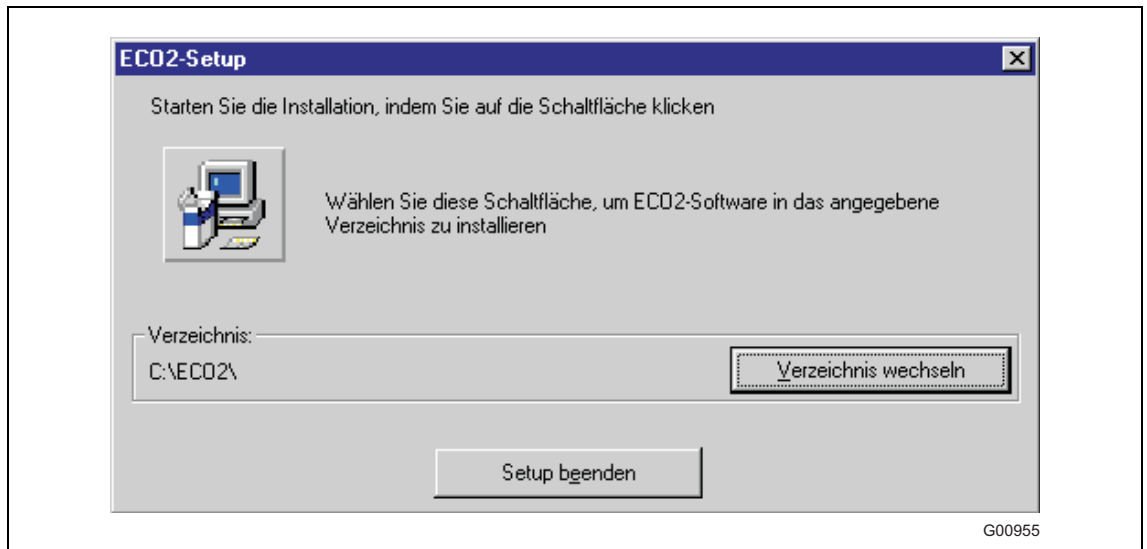

Fig. 5

Click the computer icon to begin installation.

6.4 Language selection



Fig. 6

Select the relevant language.

The installation menus are in German only, but the configuration program is available in English and French.

6.5 Starting the configuration program

Start program eco2.exe in the directory selected. The program uses COM1 as the default interface. If COM1 is already occupied, please set the preferred interface via the "connection" menu.

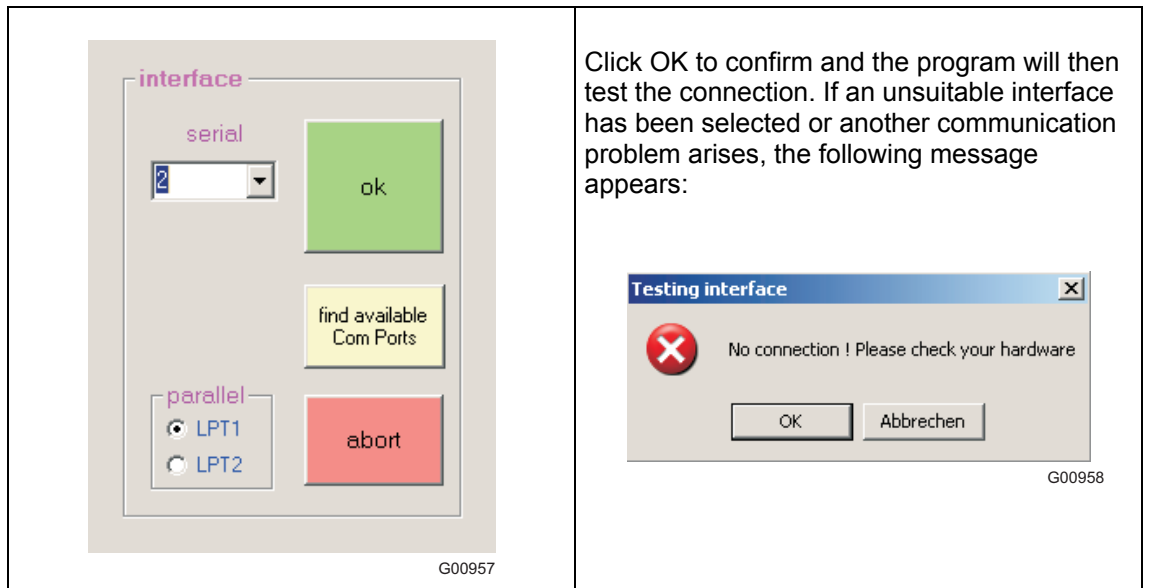

Fig. 7

In such cases, the line connections, the selected interface, and the operational readiness of the device (continuous green light on device) need to be checked.

If the interfaces have been entered correctly and the Sensyflow FMT200-ECO2 is ready to operate, the start screen for the configuration program appears.

6.6 Tab – actual settings

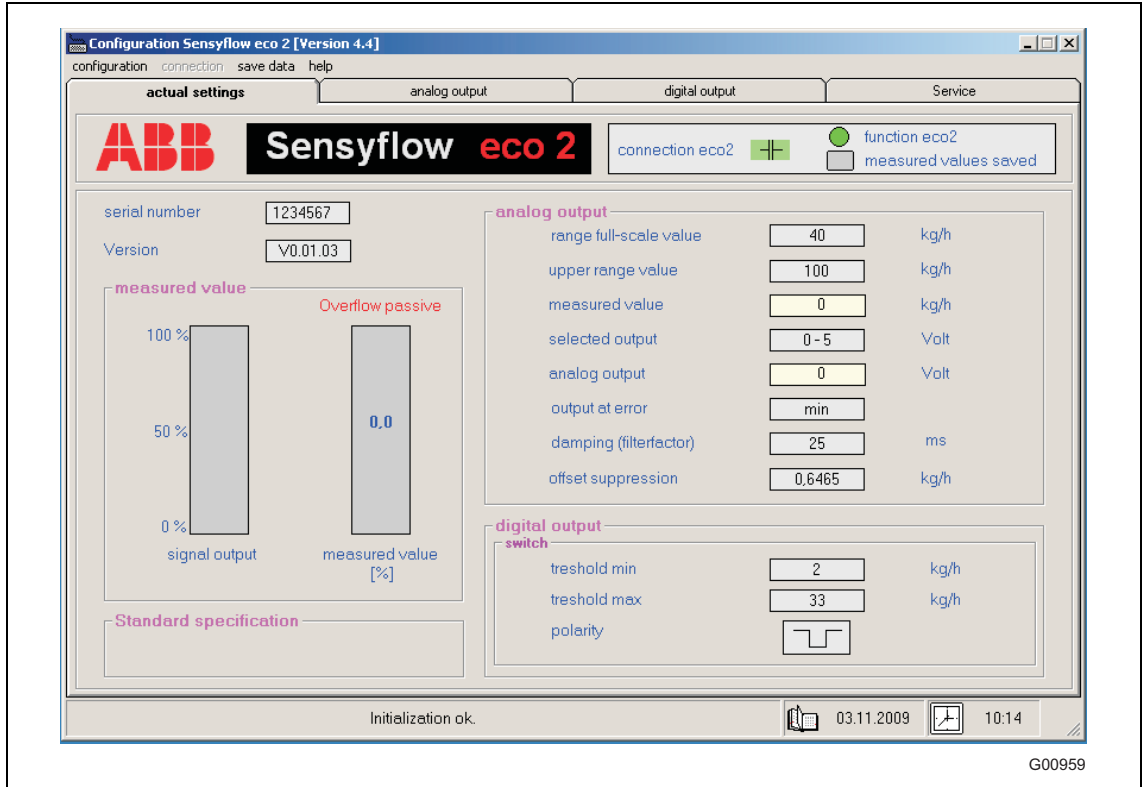

Fig. 8

This menu shows all the current settings for the device.

6.6.1 Device identification

Serial number:

Unique serial number of the device. This should be quoted with each query.

Version number:

Status of device firmware

6.6.2 Status bar

Displays current information about the connection status and help text for the action selected.

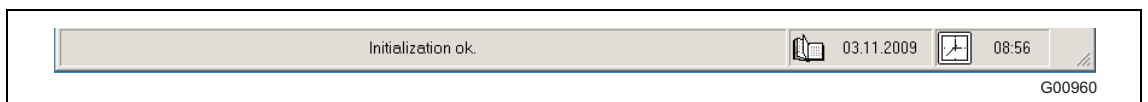

Fig. 9

The symbol at the right edge of the window shows the connection status. Green means the connection is satisfactory; red means the connection has been interrupted.

6.6.3 Standard specification

A clearly defined standard specification must be taken into account if a volume-flow unit has been selected. The absolute pressure and reference temperature must be taken from here. There is no reference condition for mass-flow units and the field is left blank.

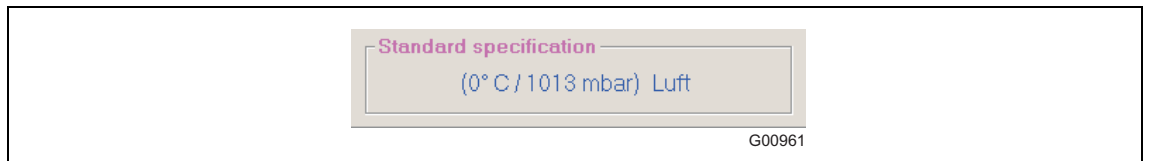

Fig. 10

6.6.4 Digital output

<p>Switch option</p> <p>The current measured value is monitored for fluctuation either side of an adjustable limit value.</p> <p>The polarity indicates how the signal is behaving between these thresholds.</p>	
<p>Impulse output option</p> <p>The device measures the amount of gas to have flown through. Once the amount in the "value" field has been reached, the device indicates this by outputting an impulse whose length and polarity can be read from here.</p>	
<p>Frequency output option</p> <p>The current measured value is indicated by a frequency at the digital output.</p> <ul style="list-style-type: none"> - Min: This frequency equates to a flowrate of 0. - Max: This frequency equates to the range full-scale value. 	

Fig. 11

6.6.5 Analog output

The analog output indicates the flowrate through the device as measured at a given moment. This value can be adapted in a wide variety of ways to suit quite different applications. The "actual settings" tab shows all the values set.

<p>Range full-scale value: Maximum measured value; can be parameterized</p> <p>Upper range value: Upper limit for device calibration, i.e., the range full-scale value cannot be set to a value beyond the calibrated range.</p> <p>Measured value: Current measurement result from the selected unit</p> <p>Selected output: Type of analog output currently being used</p> <p>Analog output: Current measurement result in the form of a selected electrical output signal</p> <p>Output at error: The Sensyflow FMT200-ECO2 indicates that an error has occurred at the analog output.</p> <p>Dumping (filter factor): Time delay for adjustable damping</p> <p>Offset suppression: Measured values below the offset suppression value are shown as a flowrate of 0.</p>	<p style="text-align: right;">G00965</p>
---	--

Fig. 12

6.6.6 Measured value

<p>The measured value area contains a bar chart showing how much of the set measurement range is currently being used. If the "switch" option for the digital output is activated, an additional bar appears.</p> <p>If the current measured value is less than the lower activated threshold, the bar turns blue; if the measured value is higher than the upper set threshold, the bar turns red. A green bar indicates the value is between the upper and lower thresholds.</p>	<p style="text-align: right;">G00966</p>
--	--

Fig. 13

6.6.7 The configuration menu

<p>Factory settings: Shows the parameters set at the factory</p> <p>Save: Saves the current parameter set to the data storage medium</p> <p>Load: Downloads a saved parameter set from the data storage medium</p> <p>Delete: Deletes a parameter set from the data storage medium</p> <p>Print: Prints off the current settings at the local printer</p> <p>Select language: English, French, German</p> <p>Select unit: Activates a unit from the list</p> <p>Add unit: See chapter 6.6.7.2.</p> <p>Delete unit: See chapter 6.6.7.2.</p> <p>Change password: For information on how to activate password protection, see chapter 6.6.7.1.</p> <p>Exit: Exits the Sensyflow FMT200-ECO2 configuration software</p>	 <p style="text-align: right; font-size: small;">G00967</p>
---	--

Fig. 14

If parameter settings have been changed in the configuration software and this has been imported into the device via the "save device data" menu item, a save / initialization phase is performed and the pilot light flashes RED.

i

IMPORTANT (NOTE)

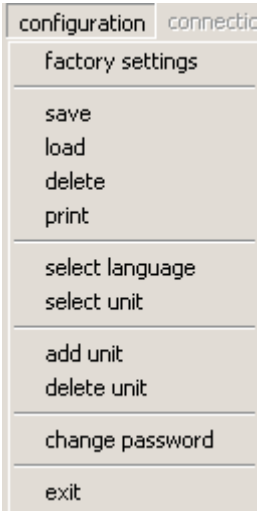
The supply voltage must not be switched off during the save / initialization phase.

The supply voltage may only be switched off when the pilot LED is "continuous green" once more. The modified parameters will not be saved properly if this rule is not obeyed. When the device is switched on again, a data inconsistency will be detected during the initialization phase, the pilot LED will switch to "continuous red", and the device will no longer function correctly.

Even though the pilot LED is red, the configuration software can be used to resume communication. The parameter data must be saved again via the "save device data" menu item. This can only be done after the symbol indicating that a program is running disappears and the status indication for the "initialization phase" is terminated.

The pilot LED is still "continuous red" at this stage. If the hardware is reset at this point by switching the supply voltage off and on, the pilot LED switches to "continuous green" and the device is operational once more.

Parameterization

6.6.7.1 Password protection

This function can be used to deny access to the tabs for making changes to the analog and digital output. As a result, changes affecting output signals can only be made if a password is entered. The "current device parameters" tab remains available. This provides an overview of the device and is used for monitoring purposes.

6.6.7.2 Freely parameterizable unit

<p>Freely definable unit: Within this context, it must be possible to represent the freely definable unit as a multiple of kg/h.</p> <p>Unit: User-defined text naming the unit</p> <p>Factor: Numerical entry Number of kg/h of air equivalent to the new unit</p> <p>Stand. spec.: User-defined text giving the standard specification on which the new unit is based</p> <p>Gas type: User-defined text</p> <p>Save: Saves the new unit to the data storage medium</p>	<p style="text-align: right; font-size: small;">G00968</p>
---	--

Fig. 15

Example:

The display is to be based on balloons per minute.

One balloon contains 7 NI of air, that is 0.007 Nm³.

Given that the standard density of air = 1.293 kg / Nm³, it takes 0.00905 kg to fill each balloon.

This means 1 kg/h equates to around 110 balloons / h or 1.84 balloons / min.

The standard specification on which the density is based assumes 0 °C and 1,013 mbar.

"Delete unit" in the "configuration" menu can be used to reject an incorrect entry.

6.7 Tab – analog output

This tab can be used to adapt the analog output. For the sake of transparency, both the current and amended values are displayed at the same time.

The modified values are saved with "save device data".

An initialization phase follows, during which no measured values are displayed and the pilot light on the device flashes RED (see 6.6.7 for information).

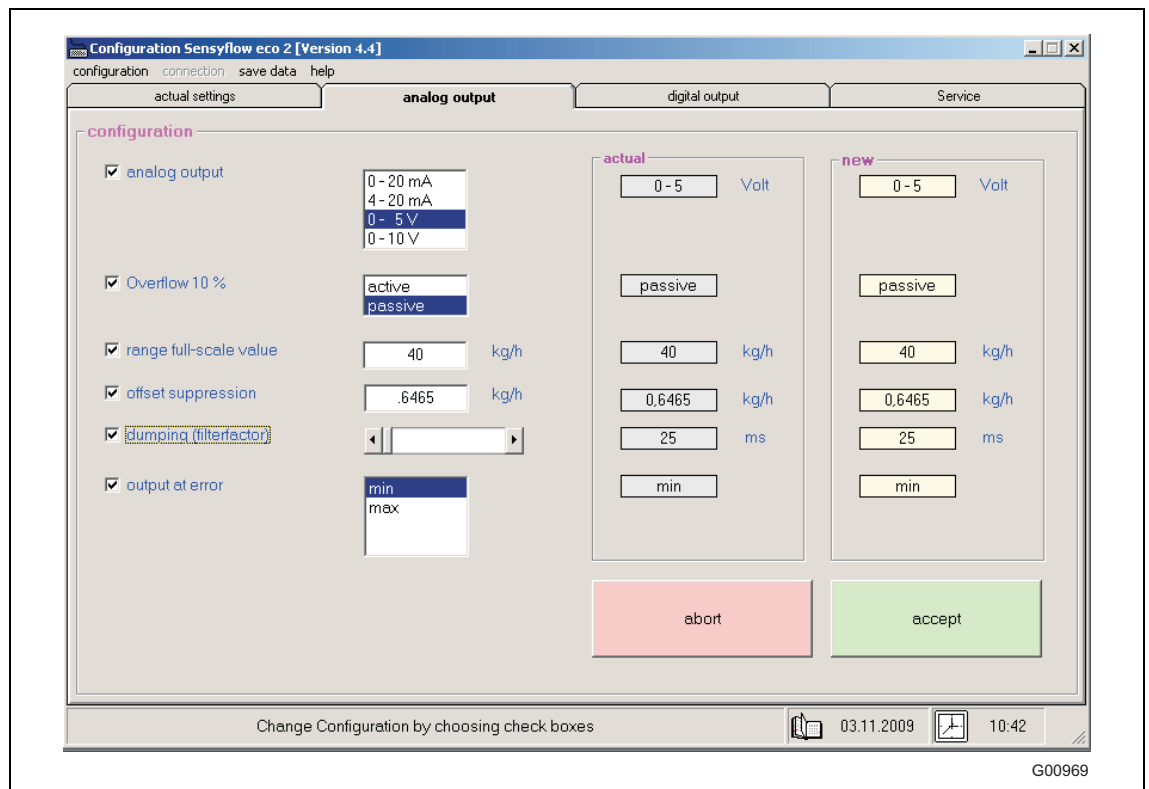

Fig. 16

Analog output:

Select an entry from the list.

Overflow 10 %

If overflow is active, any measured value up to 10 % above the set range full-scale value can be output at the analog and frequency output.

Range full-scale value:

Which flowrate value should equate to the maximum electrical output signal?

Offset suppression:

Which offset suppression value should no longer be recorded or evaluated?

Dumping (filter factor):

Which time constant should be used to damp the output signal?

Output at error:

How should the device behave when a fault (e.g., device error) has been detected?

- Min: Analog output signals 0 %
- Max: Analog output signals 100 %
- Up: Analog output signals > 100 %
- Down: Analog output signals < 0 %

Signal	0 ... 20 mA	4 ... 20 mA	0 ... 5 V	0 ... 10 V
Min	0 mA	4 mA	0 V	0 V
Max	20 (22) mA	20 (21.6) mA	5 (5.5) V	10 (11) V
Up	> 22.5 mA	> 22.5 mA	Not supported	Not supported
Down	Not supported	< 3.5 mA	Not supported	Not supported

The values in brackets apply when "overflow active" has been selected.

6.8 Tab – digital output

There are even more options for parameterizing the digital output. The output signal for the digital output is binary (0 or 24 V). Signaling polarity can be reversed.

For the sake of transparency, both the current and amended values are displayed at the same time.

The modified values are saved with "save device data".

An initialization phase follows, during which no measured values are displayed and the pilot light on the device flashes RED (see 6.6.7 for information).

The digital output can be switched between the following modes:

6.8.1 Frequency standard

In this mode, the current measured value is mapped to the digital output as a proportional frequency.

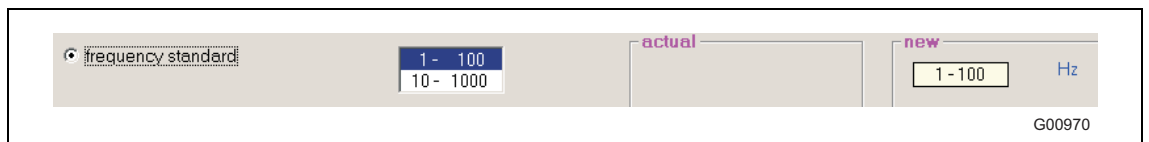

Fig. 17

In "frequency standard" mode, it is possible to switch between the two frequency ranges 1 ... 100 Hz and 10 ... 1,000 Hz. The lower frequency represents a flowrate equal to 0 % and the upper frequency represents a flowrate equal to 100 % of the set range full-scale value (see chapter 6.6.7.2).

6.8.2 Frequency variable

In this mode, the current measured value is mapped to the digital output as a proportional frequency.

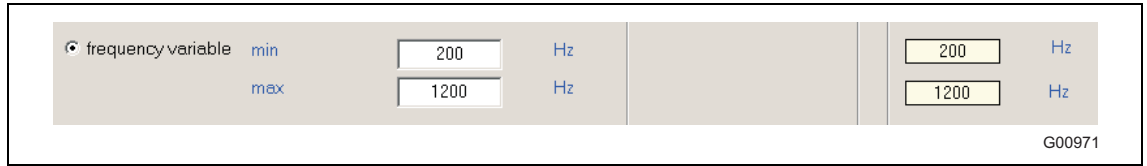

Fig. 18

The "frequency variable" mode allows upper and lower limiting frequencies to be entered. The maximum possible frequency is 2,500 Hz. The lower frequency represents a flowrate equal to 0 % and the upper frequency represents a flowrate equal to 100 % of the set range full-scale value (see chapter 6.6.7.2).

6.8.3 Impulse output

In this mode, the device adds up the total flowrate. Once the amount in the "value" field has been reached, the device indicates this by outputting an impulse whose length and polarity can be set here.

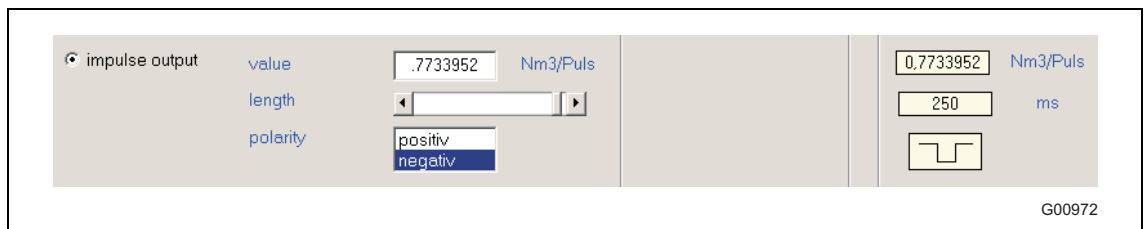

Fig. 19

Value:

Enter an amount which should flow through before an impulse is output.

Length:

Using the slider, the impulse length can be set in the range 1 ... 256 ms. Taken together, the length and value must allow an impulse and pause to be output at maximum flow.

Polarity:

This is for selecting whether a

- positive, i.e., length 0 V - impulse 24 V - length 0 V, or
 - negative, i.e., length 24 V - impulse 0 V - length 24 V,
- counting impulse is to be output.

Parameterization

6.8.4 Switch output

The current measured value is monitored here for fluctuation either side of the adjustable limit values. The polarity indicates how the signal is behaving between these thresholds.

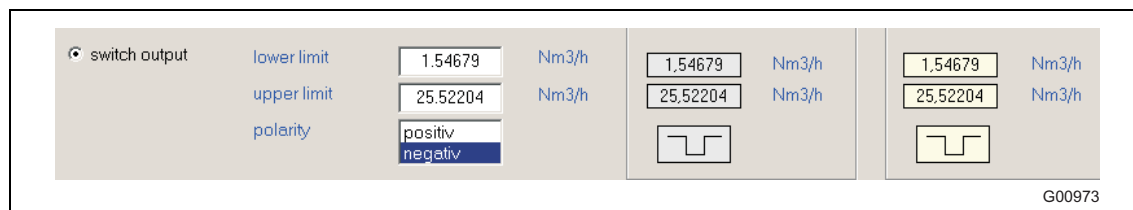

Fig. 20

6.8.5 No output

This function can be used to deactivate the digital output.

7 Maintenance / Service

All measuring systems are calibrated using in-house calibration equipment. The device does not require any maintenance. Occasional cleaning may be required where the air contains large amounts of dust or oil. We recommend connecting an upstream air filter for this type of application. Filters guaranteeing air quality to ISO 8573-1: Class 1-2 have proven particularly reliable in this context.

Cleaning the flowmeter sensor

Cleaning the flowmeter sensor will only remove particles; sticky or stubborn stains cannot be removed. If the flowmeter sensor becomes contaminated with oil or deposits which cannot be cleaned using air, it will have to be returned to the manufacturer for cleaning in a special solution. This will also involve a complete recalibration process.

Air-cleaning:

1. Remove the connecting cable's connector from the flowmeter sensor.
2. Check the pipeline is depressurized.
3. Dismantle the flowmeter sensor at the process connections.
4. Carefully blow through the flowmeter sensor with clean compressed air.
5. Visually inspect the flow-steadying special sieve (optional) for contamination. If necessary, replace with a new special sieve.
6. Carefully reinstall the special sieve in the flowmeter sensor.
7. Reconnect the connecting cable to the flowmeter sensor.



NOTICE - Potential damage to parts!

Under no circumstances should components like the honeycomb or sieve be removed from the flowmeter sensor, nor should they be bent or damaged in any other way. Failure to comply with the cleaning steps described above may cause the flowmeter sensor to be damaged beyond repair.

8 Specifications

Measuring principle

Thermal: hot-film anemometer

Input

Measured medium

Air

Measuring ranges¹⁾

0 (1) ... 100 kg / h or 0 (12) ... 1250 NI / min²⁾

Output

Analog output signal

0 ... 5 V
0 ... 10 V
0 / 4 ... 20 mA

Load

< 500 Ω

Error indication

< 3.5 mA or > 22 mA

Digital output

24 V, 20 mA

Frequency output

variable 1 ... 2500 Hz

Counter pulse

Pulse evaluation and pulse duration configurable

Alarm values

Minimum and maximum, adjustable

Polarity adjustable

Characteristics

Measured error

< ± 3 % of measured value

Repeatability

< ± 0.5 % of measured value

Response time

T₆₃ ≈ 25 ms; T₉₈ ≈ 90 ms

Influences

Temperature effect

< 0.1 % / K of measured value

Pressure effect

≤ 0.2 % / 100 kPa (/bar) of measured value

Pressure drop

< 10 kPa (100 mbar) at full scale and using the small flange adapter DN 25; decreasing quadratically for smaller flow rates.

Environmental conditions

Ambient temperature for flowmeter sensor

0 ... 50 °C (-13 ... 122 °F)

Degree of protection

IP 65

Storage temperature

-25 ... 85 °C (-13 ... 185 °F)

Measured medium conditions

Measured medium temperature

0 ... 50 °C (32 ... 122 °F)

Measured medium pressure

Standard: 10 x 10² kPa (10 bar abs.)
High pressure version: 16 x 10² kPa (16 bar abs.)

Construction

Weight

0.51 kg (accessories see ordering information)

Material

Flowmeter sensor: aluminium, Hostadur, tinned Cu, glass
Process connections: aluminium
Fittings: aluminium

Process connection

Small flange adapter ISO KF flange;
Threads G 3/8", G 3/4", G 1/2", G 1";
Legris tube adapter, Transair adapter

Electrical connection

Sub-D connector, serie 712, 8-pin, IP 65

Power supply³⁾

Voltage

24 V DC ± 10 %

Power consumption

< 15 W

Current consumption

Peak < 1 A; operation < 0.6 A
Slow-blow fuse of at least 2 A recommended

Communication interface

RS 232

Approvals for explosion protection (zone 2 and zone 22)

Gas: ATEX II 3 G EEx n A II T4 X
Dust: ATEX II 3 D T 135 °C IP 65 X

Accessories (optional)

- Inlet and outlet runs
- Pipe fittings
- Connection adapter
- Quick-clamping connectors
- Reducers
- Power supply unit
- Display unit
- Display and supply unit completely installed in an IP 65 housing

- 1) Approximate values are given for applications with air under atmospheric conditions. The values in brackets indicate the low limit of the measuring range for which the measured value accuracy indicated is specified.
- 2) It is possible to specify any unit which you can transform into a mass or standard volume flow. (Can also be written as: l / min-q_N).
- 3) Power supply with safe electrical separation in accordance with EN 61010 and IEC 950, with max. output power of 150 W.

9 Dimensions

9.1 Flowmeter sensor FMT200-ECO2

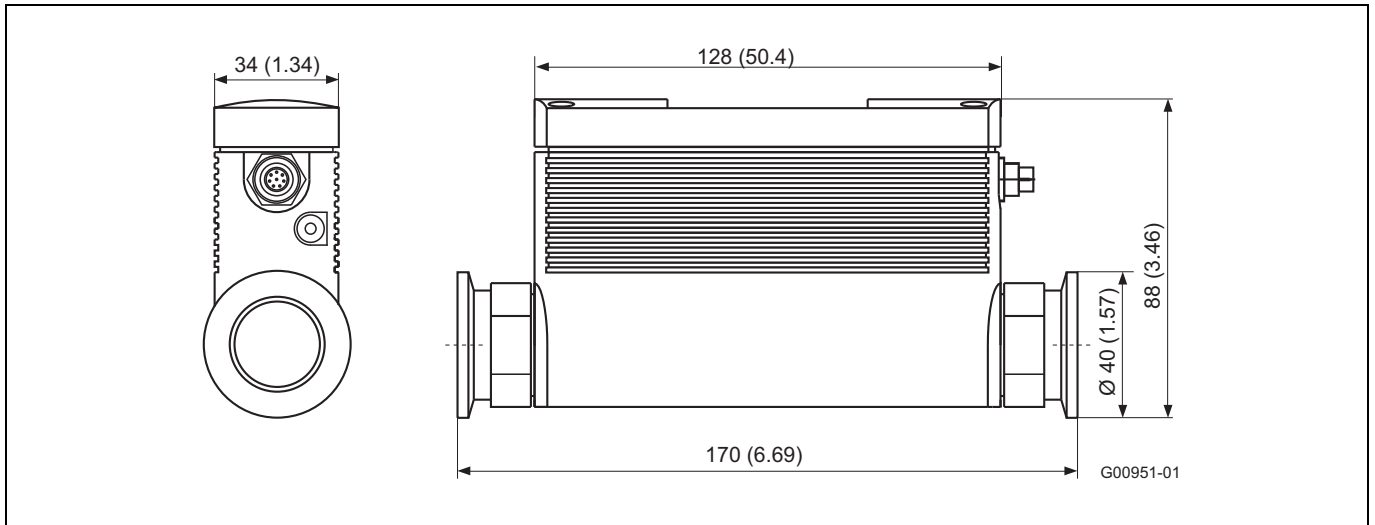

Fig. 21: Flowmeter sensor FMT200-ECO2 with mounted small flange adapter

Dimensions

9.2 Accessories

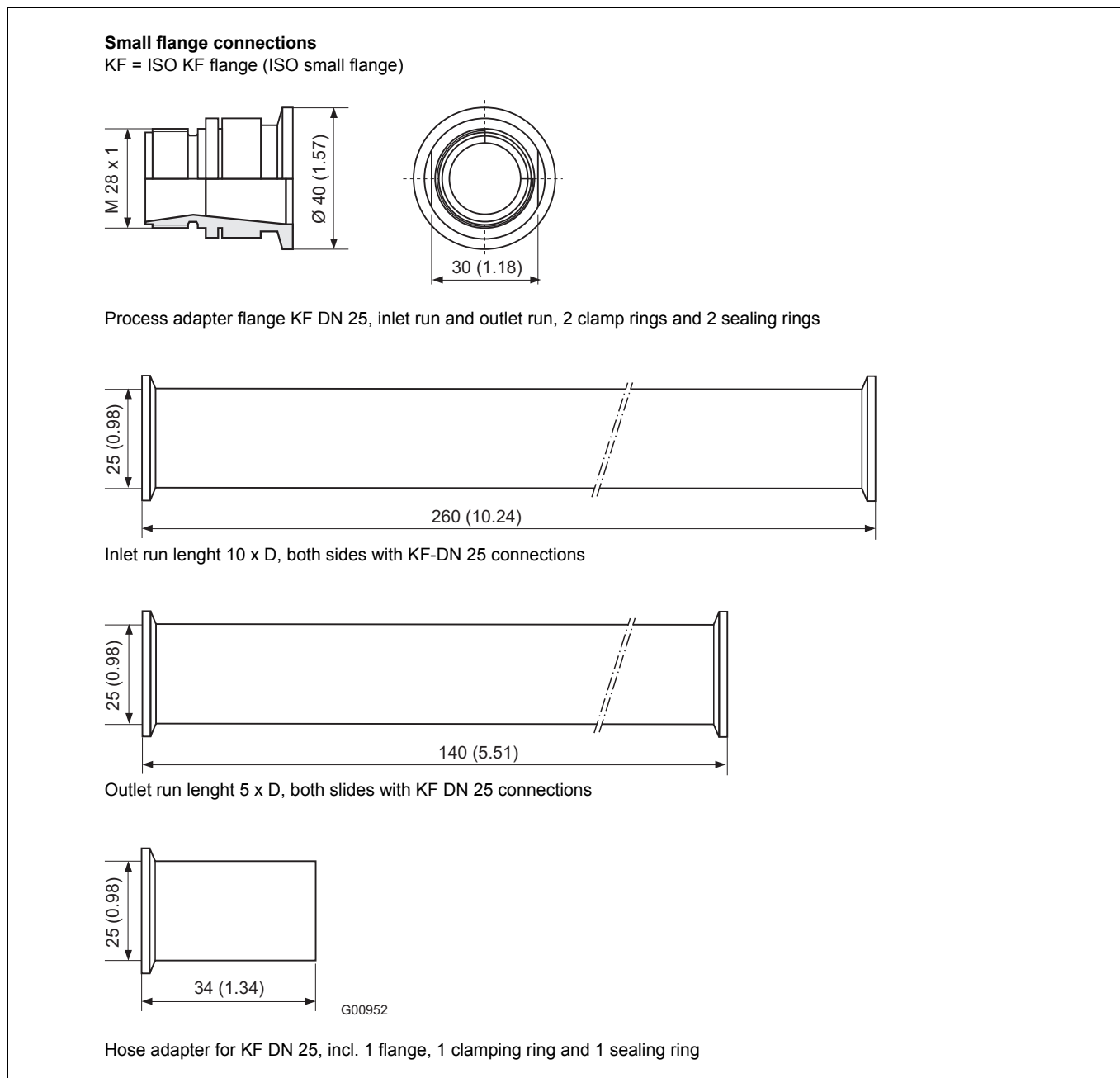
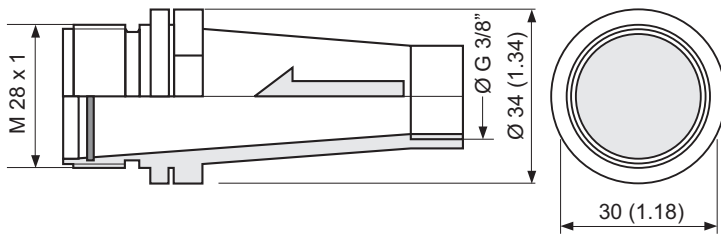

Fig. 22: Dimensions in mm (inch)

Straight undisturbed pipes must be provided as steadying lengths. On the inlet side they should have a length of approx. $10 \times D$. When using the G 1/2" and G 3/8" adapters no additional steadying lengths are required, as flow-conditioning components are implemented in the adapters on the inlet side.

Note that flow conditioner causes a considerable pressure drop. Components affecting the flow like valves or shut-off devices should be installed on the outlet side, i. e. downstream of the measuring point.

Threads and adapter



Thread G 3/8", connection for Legris-tube adapters, pair) for inlet run and outlet run; inlet run adapter includes a high-tech flow conditioner



Legris-tube adapter (pair)

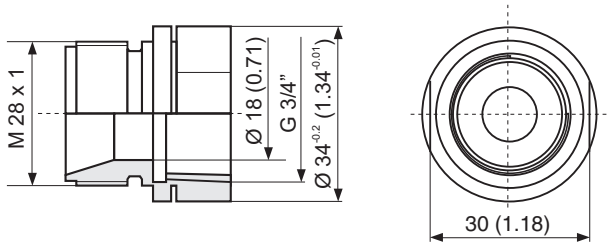

Thread G 3/4", also connection for Transair system 25 mm (pair)

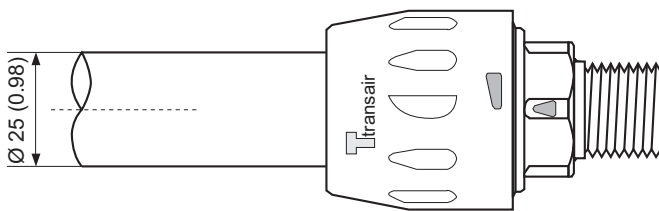

Transair adapter 25 mm (pair)

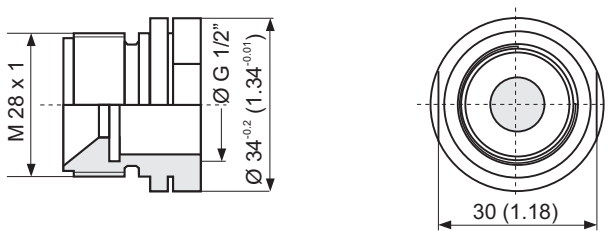

Thread G 1/2" (pair) for inlet run and outlet run. Inlet run adapter includes a high-tech flow conditioner

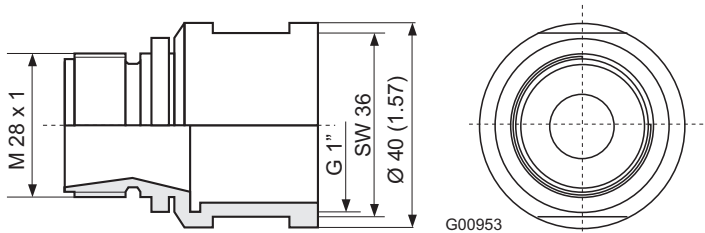

Thread G 1"

G00953

Fig. 23: Dimensions in mm (inch)

10 Configuration box (optional)

The configuration box is available as an option. It is used to simplify wiring for testing and configuration purposes. Its electric is largely based around a star hub, which distributes the signals from the device's 8-wired connecting cable to the different input and output contacts.

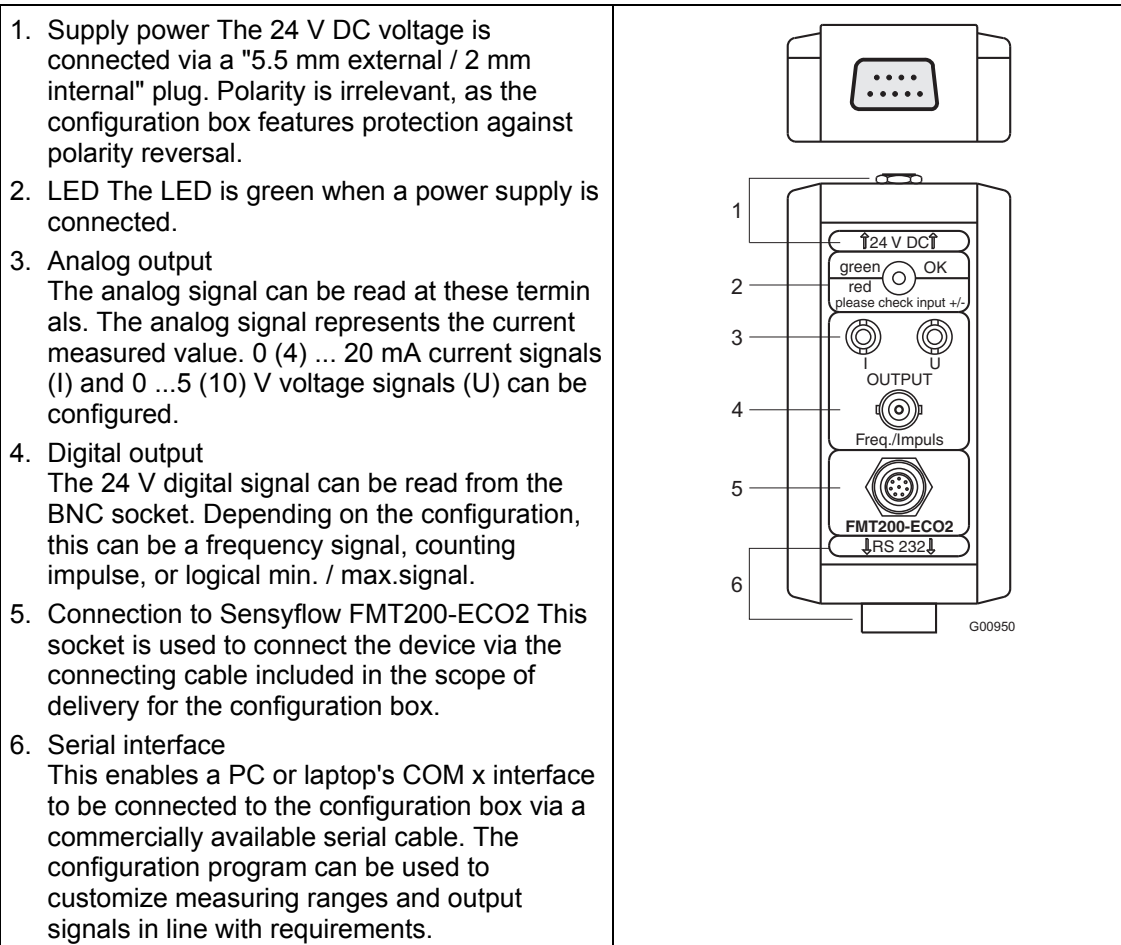

Fig. 24

11 Appendix

11.1 Decommissioning and packaging



Packaging the device ready for transport or return to the manufacturer

If the original packaging material is no longer available, wrap the device in bubble wrap or corrugated cardboard and place it in a box of sufficient size lined with a shock-absorbing material (e.g., foam rubber). The thickness of the padding should be appropriate for the device weight and type of shipment. The box must be handled with care and labeled accordingly.

For overseas shipment, always add a desiccant (e.g., silica gel) and hermetically seal the device plus desiccant in a layer of polythene that is 0.2 mm thick. Use an amount of desiccant that is appropriate for the packing volume and the expected transport time (at least sufficient for 3 months). You should also line the box with a layer of union paper.

All devices returned to the manufacturer must be accompanied by a completed and signed decontamination certificate (see Appendix). Without this, ABB will not be able to process the return.

11.2 Approvals and certifications

CE mark		The version of the meter in your possession meets the requirements of the following European directives: <ul style="list-style-type: none"> - EMC directive 2004/108/EC - Low voltage directive 2006/95/EC - ATEX directive 94/9/EC
Explosion Protection		Identification for intended use in potentially explosive atmospheres according to: <ul style="list-style-type: none"> - ATEX directive (marking in addition to CE marking)
Calibration		DAkkS- / ILAC-accredited calibration equipment D-K-15081-01-00 <ul style="list-style-type: none"> - Example certificate



IMPORTANT (NOTE)

All documentation, declarations of conformity and certificates are available in ABB's download area.

www.abb.com/flow



EG-Konformitätserklärung
EC-Certificate of Compliance



Hiermit bestätigen wir die Übereinstimmung der
Herewith we confirm that our

Thermischen Massen Durchflussmesser:
Thermal Mass Flowmeter:

Modelle FMT200-ECO2 Sensyflow V14252-...
Models FMT200-ECO2 Sensyflow V14252-...

mit den grundlegenden Sicherheits- und Gesundheitsanforderungen gem. der Richtlinie 94/9/EG des Rates der Europäischen Gemeinschaft. Die Sicherheits- und Installationshinweise der Produktdokumentation sind zu beachten.
are in compliance with the Essential Health and Safety Requirements with refer to the council directives 94/9/EC of the European Community. The safety and installation requirements of the product documentation must be observed.

EG-Baumusterprüfbescheinigung/EC-Type Examination Certificate: ---

Baumusterprüfbescheinigung/Type Examination Certificate: ---

Herstellereklärung/ Certificate of compliance **BZ-13-8023**

Benannte Stelle/Notified Body: ---

Geräte-Kennzeichnung/Apparatus code:

FMT200-ECO2 II 3 G ... / II 3 D ...

Sicherheitstechnische Daten: siehe Herstellereklärung
Safety values: refer to Certificate of compliance

Angewandte Normen: EN60079-0:2006
Standards: EN60079-15:2005
 EN61241-0:2006
 EN61241-1:2004
 EN60529:1991+ A1:2000

Göttingen, 01. Dezember 2011



i.V. Klaus Schäfer
(QM Manager)

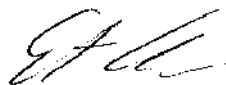

i.V. Dr. Günter Kuhlmann
(R&D Manager)

BZ-13-8022
Rev.01

ABB Automation Products GmbH

Postanschrift:
Dransfelder Str. 2
D-37079 Göttingen

Besuchsanschrift:
Dransfelder Str. 2
D-37079 Göttingen

Telefon +49 551 905 0
Telefax +49 551 905 777
Internet: <http://www.abb.com/de>



EG-Konformitätserklärung
EC-Certificate of Compliance



Hiermit bestätigen wir die Übereinstimmung der aufgeführten Geräte mit den Richtlinien des Rates der Europäischen Gemeinschaft, welche mit dem CE- Zeichen gekennzeichnet sind.

Die Sicherheits- und Installationshinweise der Produktdokumentation sind zu beachten.
We herewith confirm that the listed devices are in compliance with the council directives of the European Community and are marked with the CE- marking. The safety and installation requirements of the product documentation must be observed.

Hersteller: <i>Manufacturer:</i>	ABB Automation Products GmbH, Dransfelder Straße 2, 37079 Göttingen - Germany
Gerät: <i>Device:</i>	Thermischer Massen Durchflussmesser <i>Thermal Mass Flowmeter</i>
Modelle.: <i>Models:</i>	Sensyflow FMT200-ECO2
Produktnummer: <i>Models:</i>	V14252-...
Richtlinie: <i>Directive:</i>	2004/108/EG * (EMV) 2004/108/EC * (EMC)
Europäische Norm: <i>European Standard:</i>	EN 61326-1, 10/2006 * EN 61326-2-3, 05/2007 * EN 61326-1, 10/2006 * EN 61326-2-3, 05/2007 *
Richtlinie: <i>Directive:</i>	2006/95/EG * (Niederspannungsrichtlinie) 2006/95/EC * (Low voltage directive)
Europäische Norm: <i>European Standard:</i>	EN 61010-1, 01/2009 * EN 61010-1, 01/2009 *

* einschließlich Nachträge / including alterations

Göttingen, 01. Dezember 2011

i.V. Klaus Schäfer
(QM Manager)

i.V. Dr. Günter Kuhlmann
(R&D Manager)

BZ-13-5114
Rev.01

ABB Automation Products GmbH

Postleitschrift:
Dransfelder Str. 2
D-37079 Göttingen

Bezugsanschrift:
Dransfelder Str. 2
D-37079 Göttingen

Telefon +49 551 805 0
Telefax +49 551 905 777
Internet: <http://www.abb.com/ce>



Herstellererklärung Certificate of Compliance



Thermischen Massen Durchflussmesser: Thermal Mass Flowmeter:

Modelle FMT200-ECO2 Sensyflow V14252-...1
Models FMT200-ECO2 Sensyflow V14252-...1

Referenz: Reference:	EG-Konformitätserklärung EC-Certificate of compliance	BZ-13-8022
Geräteart: Type of unit:	Thermischer Masse-Durchflussmesser für Gas zum Einsatz in der Zone 2 und Zone 22. Thermal Mass Flowmeter for gas, for applications in Zones 2 and 22.	
Versorgungsstromkreis Supply circuit	in Zündschutzart Nicht Funkend Ex nA II $U_n = 24V DC \pm 10\%$, $P_n < 20 W$ Die Versorgungsspannung muss mit einer IEC-Sicherung 2A träge abgesichert werden. with type of protection "non-sparking" Ex nA II $U_n = 24V DC \pm 10\%$, $P_n < 20 W$ The supply circuit must be protected by an IEC 2A slow-blow fuse.	
PE – Stromkreis: PE – circuit:	in Zündschutzart „nicht funkend“ Ex nA II with type of protection „non-sparking“ Ex nA II	
PA – Stromkreis: PA – circuit:	in Zündschutzart „nicht funkend“ Ex nA II with type of protection „non-sparking“ Ex nA II	
Umgebungstemperatur: Ambient temperature:	$\pm 0^\circ C \dots +50^\circ C$	Mediumtemperatur: $\pm 0^\circ C \dots +50^\circ C$ Medium temperature:
Kennzeichnung: Marking:	II 3G Ex nA II T4 II 3D Ex tD A22 IP65 T135°C	
Anmerkungen/Remarks:		
Bereich:	Der Sensor darf ausschließlich im Bereich der Zone 2 eingesetzt werden. Der Anschlusskasten mit der Elektronik kann sowohl in der Zone 2 als auch in der Zone 22, für nicht leitende Stäube bis 5 mm Schichtdicke, installiert werden. Hybridgemische sind nicht zulässig.	
Area:	The sensor may only be used in Zone 2. The connection box containing the electronic components can be installed in Zone 2 as well as in Zone 22 for non-conducting dust with a layer thickness of up to 5 mm. Installation in an area with hybrid mixtures is not allowed.	
Hilfsenergie:	Der Anwender hat sicherzustellen, dass die Versorgungsspannung 36V DC nicht überschreitet. Die Hilfsenergie ist mit sicherer Trennung gemäß den Anforderungen nach EN 61010 sowie mit einer maximalen Ausgangsleistung von 150 W auszuführen.	
PowerSupply:	The customer has to guarantee that the mains voltage 36V DC does not exceed. The power supply is to be carried out with secure isolation in accordance with the EN 61010 as well as with a maximum output power of 150 W.	



Seite/Page 2/3

Schutzklasse IP65 Um die Einhaltung der Schutzklasse IP65 zu gewährleisten, muss bei abgezogenem Anschlusskabel die Schutzkappe auf dem Stecker aufgeschraubt werden. Es dürfen nur Stecker zum Anschluss an ECO2 mit der IP – Schutzkappe IP65 eingesetzt werden. Es ist darauf zu achten, dass die O-Ringdichtung des Steckers nicht beschädigt ist bzw. durch unsachgemäßen Gebrauch beschädigt wird.

Type of Protection IP65:

In order to guarantee compliance with the type of protection IP65 the protective cover must be unscrewed at the connector if the connecting cable is diverged. Only couplers with protective cover IP65 may be used. It is to be ensured that the O-ring seal of the coupler is not damaged and/or is not damaged by inappropriate use.

Stecken und Ziehen des Anschlusssteckers inkl. Zugentlastung

Das Anschlusskabel darf nur im spannungslosen Zustand am Gerät gesteckt oder gezogen werden. Ebenfalls ist für eine entsprechende Zugentlastung zu sorgen.

Plug and drag of the connector inclusive stress relief.

The connecting cable only may be plugged and dragged voltageless. Also a corresponding stress relief has to be guaranteed.

Eingriff am Gerät: Das Gerät darf vom Anwender nicht geöffnet werden.
Intervention on the device. *The device may not be opened by the customer.*

Inbetriebnahme:

Der Prozessanschluss des Masse-Durchflussmessers erfolgt mittels Sensyflow Rohrbauteil. Das Sensyflow Rohrbauteil muss so montiert werden, dass Staubdichtheit gewährleistet wird. Der Anschlusskopf mit der Kabelverschraubung gewährleistet bei geschlossenem Deckel die Schutzart IP 65.

Start-up: *The process connection of the Thermal Mass Flowmeter is established with a Sensyflow pipe component. The Sensyflow pipe must be mounted in such a way that its dust-proof quality is guaranteed. With the cover closed, the connecting head equipped with a cable gland, guarantees a type of protection IP 65.*

Verwendung: Der thermische Masse-Durchflussmesser Sensyflow FMT200-ECO2 dient zur Messung von Gasdurchflüssen in verschiedenen Nennweiten gemäß Datenblatt.

Application: *The Thermal Mass Flowmeter FMT200 Sensyflow ECO2 is used to measure gas flows in different nominal sizes, according to the Data Sheet.*

Montage und Demontage: Bei der Montage und Demontage dürfen keine elektrischen Spannungen anliegen. Wenn der Masse-Durchflussmesser demontiert wird, muss sichergestellt sein, dass der Prozess abgeschaltet ist und keinerlei Drücke anstehen bzw. eine Wechselarmatur verwendet wird. Gegen das Austreten von gefährlichen Medien sind geeignete Maßnahmen zu treffen.

Mounting and Dismounting: *During mounting and dismantling operations, no electrical voltages may be applied. If the Thermal Mass Flowmeter is to be dismantled, it must be ascertained that the process has been shut down and that no pressures exist, or that a hot tap fitting is used. Appropriate measures must be taken to ensure that no leakage of dangerous media occurs.*

BZ-13-8023 Rev.1



Seite/Page 3/3

Instandhaltung: Die Funktion ist regelmäßig zu überprüfen und bei Störungen muss der Masse-Durchflussmesser ausgewechselt werden. Es dürfen nur Originalteile verwendet werden. Bei der Montage des Sensyflow Rohrbauteils muss der Anwender die Staubdichtheit gewährleisten.

Maintenance: *The function must be checked regularly and the Thermal Mass Flowmeter must be replaced in case of malfunction. Only genuine parts may be used. When mounting the Sensyflow pipe component the user must ensure its immunity to dust.*

Potentialausgleich: Falls ein Anschluss an den Potentialausgleich erforderlich ist, kann dies über die Rohrleitung erfolgen.

Equipotential-bonding: Should a connection to the equipotential bonding become necessary, this can be effected via the pipeline.

Einsatz: Der Masse-Durchflussmesser Sensyflow FMT200-ECO2 ist unter Beachtung der elektrischen Kenngrößen als Betriebsmittel der Kategorie 3 sowohl in der Zone 2 als auch in der Zone 22 einsetzbar. Bei der Errichtung ist die EN 61241-14 (Klassifikation VDE 0165 Teil 2 bzw. Teil 2/A2) für Staub und die DIN EN 60079-14 (VDE 0165 Teil 1) für Gas zu beachten. Außerdem muss die Betriebsanleitung des Sensyflow FMT200-ECO2 beachtet werden.

Operation: *The Mass Flowmeter FMT200 Sensyflow ECO2 can be operated as an electrical appliance in both Zones 2 and 22 by respecting the electrical characteristics of Category 3. During installation, the EN 61241-14 (VDE 0165 Part 2 and/or Part 2/A2 classification) for dust and the DIN EN 60079-14 (VDE 0165 Part 1) for gas must be respected. In addition, the Operating Instructions for FMT4200 Sensyflow ECO2 must be adhered to.*

Göttingen, 01. Dezember 2011

i.V. Klaus Schäfer
(QM Manager)

i.V. Dr. Günter Kuhlmann
(R&D Manager)

BZ-13-8023 Rev.1



Calibration - Certificate

Customer: Muster F-No.: 123456789 X001

Flowmeter Data

Flowmeter: Sensyflow FMT200-ECO2
 ID: 34223294 Serial-No.: 00123456
 Type-Code: 14252-

Application Data

Diameter: NW25 Analog Output: 0 - 10 Volt
 Pressure range: 0 - 10 bar
 Gas: Air
 Selected measuring range: 100 kg/h
 Calibrated (max) measuring range: 100 kg/h
 Standard Conditions: (0° C / 1013 mbar)

Calibration

The accuracy of the instrument for the calibrated range is < 3 % of reading. The repeatability is < 0,5% of reading.

Calibration setup: DN 25, filter, 10°D upstream length, Instrument, 5°D downstream length
 Gas: Air
 Gas Temperature: 22°C +-2K
 Gas Pressure: 1005 +- 25 mbar Testrig: PS0053

Sensyflow reference system with accuracy < 1% of reading. The reference system is traceable to National Standards.
 (calibration marks 1898 / 1899 DKD-K-05701 2010-08).

Final Test

We confirm, that this measuring system has been checked according to the regulations and that it complies with the technical data.

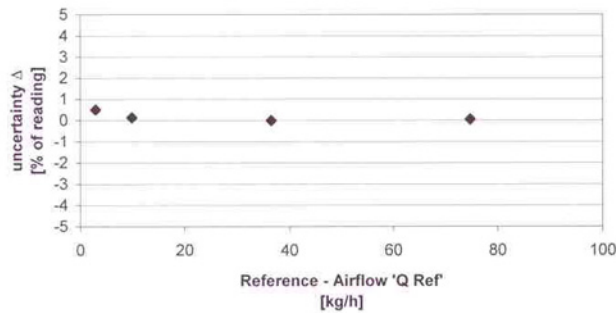

Q Ref. [kg/h]	Δ [%]
2,98	0,50
9,94	0,13
36,49	-0,01
74,79	0,04

37079 Göttingen

04/05/2012

Inspector:

2310

Statement on the contamination of devices and components

Repair and / or maintenance work will only be performed on devices and components if a statement form has been completed and submitted.

Otherwise, the device / component returned may be rejected. This statement form may only be completed and signed by authorized specialist personnel employed by the operator.

Customer details:

Company:

Address:

Contact person:

Telephone:

Fax:

E-mail:

Device details:

Type:

Serial no.:

Reason for the return/description of the defect:

Was this device used in conjunction with substances which pose a threat or risk to health?

Yes No

If yes, which type of contamination (please place an X next to the applicable items)?

Biological Corrosive / irritating Combustible (highly / extremely combustible)

Toxic Explosive Other toxic substances

Radioactive

Which substances have come into contact with the device?

1.

2.

3.

We hereby state that the devices / components shipped have been cleaned and are free from any dangerous or poisonous substances.

Town/city, date

Signature and company stamp

ABB has Sales & Customer Support expertise in over 100 countries worldwide.

www.abb.com/flow

The Company's policy is one of continuous product improvement and the right is reserved to modify the information contained herein without notice.

Printed in the Fed. Rep. of Germany (06.2012)

© ABB 2012

3KXF421004R4201



ABB Limited

Oldends Lane, Stonehouse
Gloucestershire, GL10 3TA
UK

Tel: +44 (0)1453 826661
Fax: +44 (0)1453 829671

ABB Inc.

125 E. County Line Road
Warminster, PA 18974
USA

Tel: +1 215 674 6000
Fax: +1 215 674 7183
measurement@us.abb.com

ABB Automation Products GmbH

Dransfelder Str. 2
37079 Goettingen
Germany

Tel: +49 551 905-534
Fax: +49 551 905-555