



70x70x20 mm

23.5~29.0 CFM



	Bearing	Rating Voltage (VDC)	Power Current (mA)	Power Consumption (WATTS)	Speed (RPM)	Air Flow (CFM)	Static Pressure (Inch-H ₂ O)	Noise (dBA)	Weight (g)	Curve
	● VAPO									
ME70201V1-0000-A99	●	12	130	1.56	3200	29.0	0.14	33.0	60.0	1
ME70201V2-0000-A99	●	12	99	1.19	2900	27.0	0.12	30.0	60.0	2
ME70201V3-0000-A99	●	12	77	0.93	2600	23.5	0.09	26.0	60.0	3
ME70202V1-0000-A99	●	24	66	1.59	3200	29.0	0.14	33.0	60.0	1
ME70202V2-0000-A99	●	24	56	1.35	2900	27.0	0.12	30.0	60.0	2
ME70202V3-0000-A99	●	24	44	1.06	2600	23.5	0.09	26.0	60.0	3

Model		(VDC)	(mA)	(WATTS)	(RPM)	(CFM)	(Inch-H ₂ O)	(dBA)	(g)	Curve
EE70201S1-0000-A99	○	12	135	1.62	3200	29.0	0.14	33.0	60.0	1
EE70201S2-0000-999	○	12	110	1.32	2900	27.0	0.12	30.0	60.0	2
EE70201S3-0000-999	○	12	90	1.08	2600	23.5	0.09	26.0	60.0	3
EE70202S1-0000-A99	○	24	64	1.54	3200	29.0	0.14	33.0	60.0	1
EE70202S2-0000-999	○	24	55	1.32	2900	27.0	0.12	30.0	60.0	2
EE70202S3-0000-999	○	24	44	1.06	2600	23.5	0.09	26.0	60.0	3

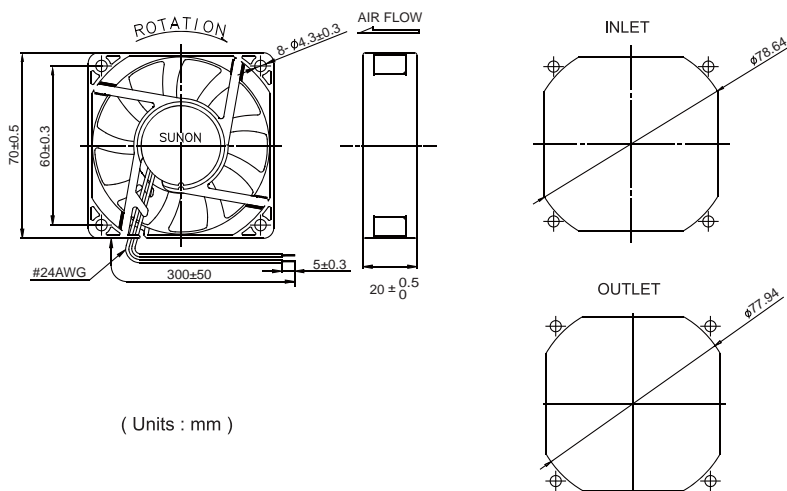
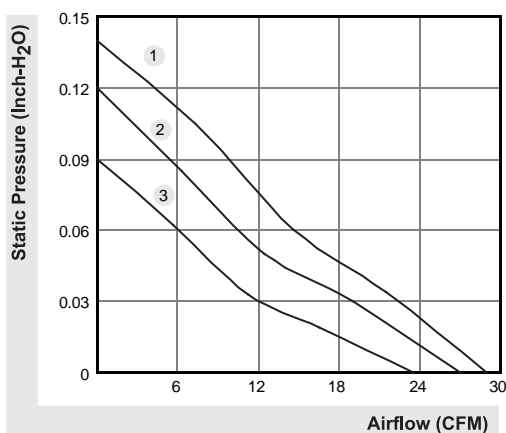

*All model could be customized. Please contact with Sunon Sales.

*Specifications are subject to change without notice. Please Visit SUNON web site at <http://www.sunon.com> for update information.